





# Grupo Remolques del Norte, S.A. de C.V.

Es una empresa de producción y comercialización de remolques con casi 30 años de experiencia en la manufactura de implementos agrícolas que, además de remolques, incluyen otros como sembradoras, desgranadoras para maíz y cultivadoras. Todo esto apegándose a las normas establecidas en México para la fabricación de dichas herramientas.



“El que siembra escasamente, escasamente también cosechará; y el que siembra abundantemente, abundantemente también recogerá. – 2 Corintios 9:6

# Índice



## Accesorios

Aros / Bisagras.....	1
Bastón / Cadenas de Seguridad / Gata / Cinchos.....	2
Candado para jalones / Cerraduras.....	3
Chavetas / Cinta Reflejante / Copas / Domos, Estrator y Ganchos.....	4
Hules / Jaladeras y Cerraduras / Lineas para freno kit.....	5
Mangueras y Manijas / Matraca para Dolly / Pasadores.....	6
Plaquita y Plasticos / Puerta Rampa.....	7
Resortes .....	8
Rodamientos y Rodillos / Tensores / Tope.....	9
Tornillos.....	10
Tubos.....	11
Tuercas / Ventilador .....	12

## Accesorios para Ejes

Ajustadores y Arandelas / Balatas.....	13
Baleros / Birlos.....	14
Espigas.....	15
Frenos.....	16
Grampas / Magnetos....	17
Masas.....	18
Tambores / Retenes.....	19
Soportes / Tapa para masa.....	20
Taza para masa / Tuercas.....	21

Accesorios  
de arrastre

Barras.....	22
Bases para bola.....	24
Kita base y bola escondida.....	25

Ejes

Ejes Normales de 2,000-7,000 lbs.....	28
Ejes Drop 3,500-7,000 lbs .....	29
Ejes Sin Masa.....	30
Ejes Torflex 4" 3,500-7,000 lbs Grado UP con freno / Ejes Dexter.....	31

Eléctricos

Adaptadores para enchufes / Adaptador p/control de freno.....	32
Arneses.....	33
Bases metálicas / Cable C-16.....	35
Cable uso rudo / Conectores eléctricos / Control de freno.....	36
Convertidor de luces / Enchufes.....	37
Interruptor / Sistema de frenado / Sistema Electro-hidráulico.....	38

# Índice



## Fenders

Fender para remolque lámina lisa / lámina antiderrapante.....	39
Fender para remolque lámina aluminio lisa / lámina aluminio antiderrapante.....	40
Estribos para remolque lámina aluminio antiderrapante / Liner para fender / Tapas.....	41
Estribos para remolque lámina lisa.....	42

## Gatos

Gatos mecánicos Bulldog / Gato Norte.....	43
Gatos mecánicos Ram.....	44
Engranajes / Gato Eléctrico / Gato Estabilizador.....	45
Manivelas / Palancas / Patas para g.....	46
Ruedas / Tubos.....	47

## Jalones y Bolas

Jalones Tipo A 2" / Jalones para Lanza Recta.....	48
Jalones Actuador hidráulico / Tipo A hidráulico / Jalones ajustables.....	49
Jalones mini quinta rueda / Cuello de ganzo / Tow Bar.....	50
Jalones de Argolla / Jalones de Gancho.....	51
Jalones para chasis.....	52
Jalones Canasta.....	54
Jalones Perno Rey / Bases para jalón / Kit de reparación.....	55
Bolas para jalón.....	56

## Llantas y

## Rines

Kit de llantas y rines.....	58
Llantas / Rines.....	59

## Muelles

Muelles de doble ojo / Muelles deslizables / Maestra.....	60
---	----

## Suspensión y

## Accesorios

Amortiguadores / Balancines / Bujes.....	61
Colgantes / Kit de suspensión.....	62
Solerita / Suspensión.....	63

## Luces

Kit de Luces / Lámparas.....	64
Luces LED con hule y enchufe / Luces con base metálica .....	65
Luces con hule y enchufe.....	66
Luces p/Domo / Luces p/Palanca / Luces con base gris.....	67
Reflectores / Switch / Accesorios para luces.....	68
Luces TecNiq.....	69

# Índice



## Defensas solo para Diesel

<b>Chevrolet delantera frente c/malla / Dodge delantera frente c/malla .....</b>	<b>71</b>
<b>Ford delantera frente c/malla / GMC delantera frente c/malla.....</b>	<b>72</b>
<b>Chevrolet y GMC trasera / Dodge trasera.....</b>	<b>73</b>

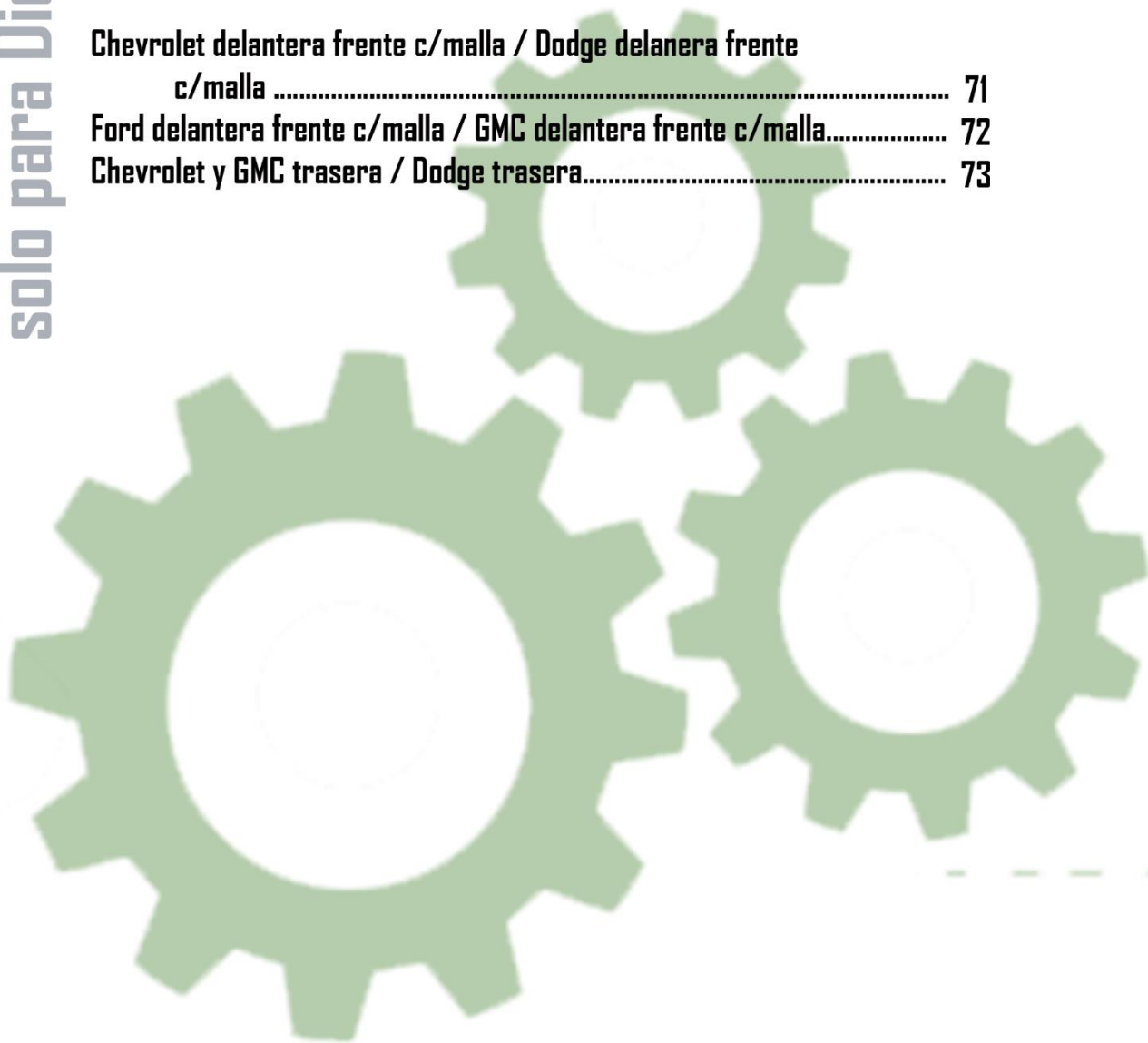

# Accesorios





## Descripción

## Clave

- |    |   |         |
|----|---|---------|
| 1. | Aro D 3/16 " c/base de zinc p/empotrar                              | B601    |
| 2. | Aro O 3/8" X 2 OD X 1-3/8" ID (5,000 lbs) c/base de zinc p/empotrar | B801AK  |
| 3. | Aros D 1/2" c/base 2,500lbs. (Austin)                               | ARO5 8  |
| 4. | Aros D 1/2" de zinc amarillo CURT                                   | J-704   |
| 5. | Aros D 1/4" c/base (zinc)   | B20     |
| 6. | Aros D 5/8" c/base para soldar (Austin)                             | 711     |
| 7. | Aro O 7/16" c/base para empotrar (6,000 lbs)                        | 7500158 |
| 8. | Aro D 3/8" c/base (zinc)  | ARO3 8  |

## Aros



## Bisagras

## Descripción

## Clave

- |     |                               |           |
|-----|-------------------------------|-----------|
| 9.  | Bisagra 4K SS 5/16 Offset     | 4K SS 516 |
| 10. | Bisagra 546.0 furgocar 8.66"  | 546 0     |
| 11. | Bisagra 157-100 Polar Chicago | 157-100   |
| 12. | Bisagra Imperial 14"          | 14-UC     |
| 13. | Bisagra Imperial 16"          | BI16      |

## Bastón, Cadena de Seguridad y Gata

Descripción	Clave
1. Cadena 3/8" x 20' c/ganchos	CAD3820
2. Cadena 5/16" x 20' c/ganchos	CAD51620
3. Cadena Towking de seguridad p/gancho	710018
4. Cadena de seguridad Towking de 1/4" x 54"	710021
5. Cadena de seguridad de 1/4" x 54"	SC1454
6. Cadena de seguridad de 5/16" x 30" (7,600 lbs)	SC51630
7. Cadena de seguridad p/gancho	GNSC3835
8. Bastón metalico p/ajustar cadena o cincho	EB312
9. Gata para cadena de 3/8" y 5/16" 5,400 lbs.	LTB51638



## Cinchos



Descripción	Clave
10. Cincho 1" x 12' banda textil amarillo c/tensor 1.5 # p/pza	RS115
11. Cincho 1" x 17' banda textil c/matraca 1.5 # p/pza	CINCHO1N
12. Cincho 2" x 27' banda textil c/matraca y gancho de varilla 5.4 # p/pza	CINCHO
13. Cincho 2" x 27' banda textil c/matraca y gancho plano 5.4 # p/pza	CINCHOFH
14. Cincho 4" x 30' banda textil c/gancho plano	RS430
15. Cincho para dolly	CDOLLY

## Descripción

## Clave

- |     |  |          |
|-----|--|----------|
| 1.  | Candado c/bola para jalón CURT                 | 23659    |
| 2.  | Candado de 1/4" p/jalón Dead Bolt .6 # p/pieza | RC-4     |
| 3.  | Candado de 5/8"                                | TAIAH030 |
| 4.  | Candado de 5/8" Buyers                         | BLHP200  |
| 5.  | Candado de 5/8" SLEVED Buyers                  | BLHP400  |
| 6.  | Candado de 5/8" Master Lock                    | 75740    |
| 7.  | Candado de 5/8" Quitaruido CURT                | 23590    |
| 8.  | Candado de 5/8" Towking                        | 708010   |
| 9.  | Candado para jalón cuello de ganzo (doble)     | 8200070  |
| 10. | Candado universal para jalón                   | 75695    |

## Candados para jalones



## Cerraduras



## Descripción

## Clave

- |     |  |                |
|-----|--|----------------|
| 11. | Cerradura chapa cromada c/llave 1 # p/pieza                | CHAPAC         |
| 12. | Chapa con cierre de 2 puntos y 4 orificios para atornillar | 16-4876-SSU-10 |
| 13. | Chapa con gancho   | L8800 SS       |
| 14. | Chapa c/llave 2701 de acero inoxidable                     | 2701 SS        |
| 15. | Chapa cromada c/doble llave                                | LR31031110     |
| 16. | Chapa vector c/manivela T                                  | 275321-06      |
| 17. | Chapa vector c/manivela T Negra                            | 272021-06-S1   |

## Chavetas

Descripción	Clave
1. Chaveta 7/16 c/aro .098 # p/pieza	CH7
2. Chaveta de 1/4 c/aro	CH14ARO

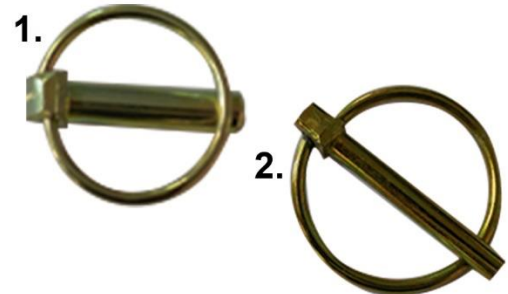

## Cinta Ref.



Descripción	Clave
3. Cinta reflejante 3M blanco de 2" por mts.	CRB3M
4. Cinta reflejante 3M rojo de 2" por mts.	CRR3M
5. Cinta reflejante 3M rojo y blanco de 2" por mts.	465 1

## Copas



Descripción	Clave
6. Copa cromada p/rin 3/4 awc	C5150L
7. Copa cromada p/rin 6 birlos	C4250
8. Copa cromada p/rin chevy	C550

## Domos, Estator y Ganchos

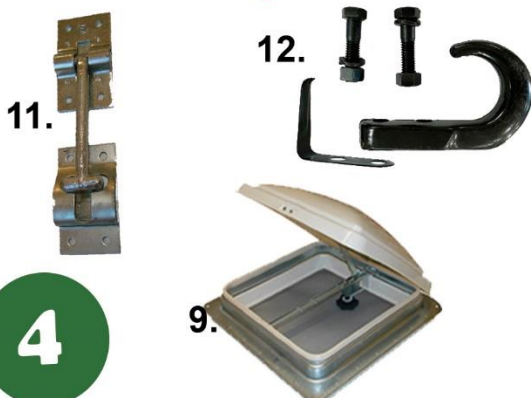

Descripción	Clave
9. Domo p/oficina de 14"	D14
10. Estator de autoinflado	31314-21
11. Gancho cromado p/puerta	G-CP
12. Gancho negro CURT c/acces.	22411

## Hules



Descripción	Clave
1. Hule p/manivela de 2"	HULE2
2. Hule para varilla de 3/4"	RVH-70
3. Hule para moldura	CET50 TK
4. Hule para piso de remolque 48" x 72" x .75"	MR487275
5. Hule tapón p/tapa de masa 10,000 lbs (ALKO)	HULEA
6. Hule tapón p/tapa de masa 10,000 lbs (DEXTER)	HULED

## Jaladeras y Cerraduras

### Descripción

### Clave

- |  |          |
|--|----------|
| 7. Jaladera cromada de 7"                        | TB550 CH |
| 8. Juego de cerradura p/puerta trasera (pasador) | PH 158   |

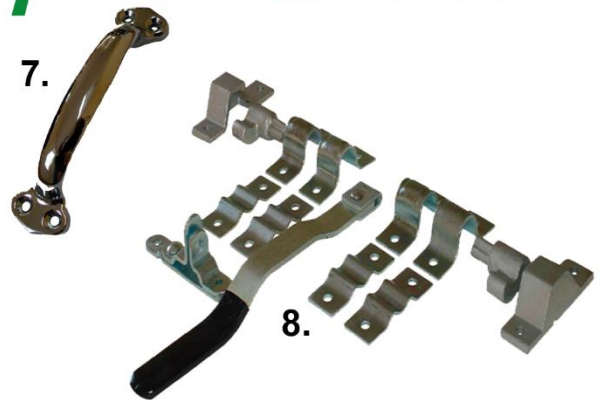

## Lineas p/freno kit

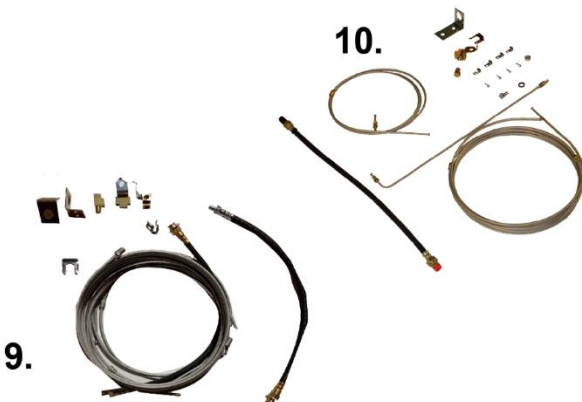

Descripción	Clave
9. Línea p/freno kit de 10,000 lbs	LKH10
10. Línea p/freno kit de un eje	80892

## Mangueras y Manijas

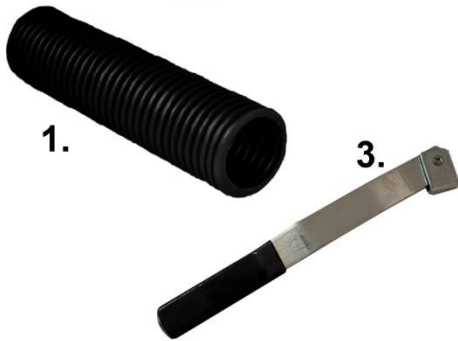

### Descripción

### Clave

- |  |               |
|--|---------------|
| 1. Manguera corrugada y ranurada de 1/2" rollo de 2200 mts | MAN12         |
| 2. Manguera de succión 100SB 3"                            | MAN-100SB-300 |
| 3. Manija p/cerradura PH-158                               | 158 100       |

## Matraca p/Dolly

### Descripción

### Clave

- |                       |        |
|-----------------------|--------|
| 4. Matraca para Dolly | MDOLLY |
|-----------------------|--------|



## Pasadores



### Descripción

### Clave

- |   |        |
|---|--------|
| 5. PasadorTowking de 5/8" sencillo con clip | 706001 |
| 6. Pasador de 1/2" y 5/8" con manga CURT    | 21502  |
| 7. Pasador de 5/8" Perma Pin                | F-582  |
| 8. Pasador de 5/8" sencillo con clip        | 75830  |
| 9. Pasador de barril galvanizado Sierra     | 61380  |
| 10. Pasador p/gato Ram de 7,000 lbs         | PG7    |
| 11. Pasador p/jalón Atwood                  | P JA   |
| 12. Pasador p/jalón Bulldog                 | P JB   |

## Plaquita y plásticos

Descripción	Clave
1. Plaquita p/gato Norte	PLGN
2. Plástico negro p/manivela	7950005
3. Plástico rojo p/manivela	7950134



## Puerta Rampa

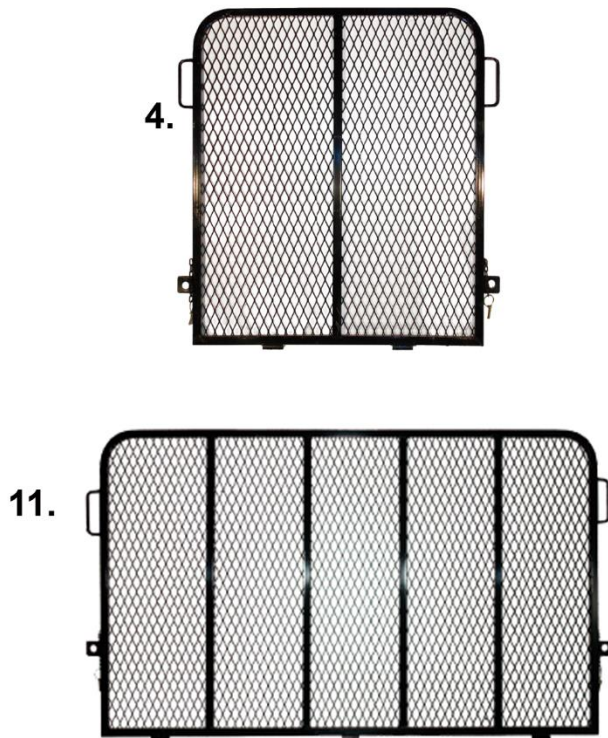

Descripción	Clave
4. Puerta Rampa p/remolque de 3.8' x 4'	PR384
5. Puerta Rampa p/remolque de 4' x 3'	PR43
6. Puerta Rampa p/remolque de 4' x 4'	PR44
7. Puerta Rampa p/remolque de 5' x 4'	PR54
8. Puerta Rampa p/remolque de 6' x 4'	PR64
9. Puerta Rampa p/remolque de 6.5' x 4'	PR654
10. Puerta Rampa p/remolque de 6.5' x 4' Reforzada	PR654R
11. Puerta Rampa p/remolque de 7' x 4'	PR74
12. Puerta Rampa p/remolque de 7' x 4' Reforzada	PR74R

## Resortes



Descripción	Clave
1. Resorte doble	GRN001
2. Resorte p/balata corto c/cabeza 3,500-7,000 lbs (azul)	046-077-00
3. Resorte p/balata de 3,500-7,000 lbs (chico) rojo	046-018-00
4. Resorte p/balata de 3,500-7,000 lbs (grande) gris	046-009-00
5. Resorte p/freno de 10,000 lbs (ajustador) amarillo	046-137-00
6. Resorte p/freno de 10,000 lbs (centrador) naranja	046-136-00
7. Resorte p/freno de 10,000 lbs (retorno) gris	046-119-00
8. Resorte p/magneto 3,500-7,000 lbs	046-080-00
9. Resorte p/magneto de 10,000 lbs	046-117-00

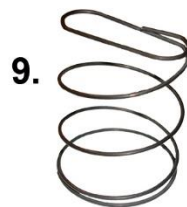



## Rodamiento y Rodillo

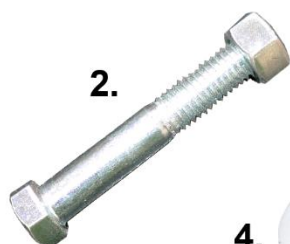

2.



4.



5.

Descripción	Clave
1. Rodillo p/puerta ganadera	RODILLO
2. Tornillo galvanizado de 1/2" x 3" de grado 5	127020240
3. Tuerca galvanizada de 1/2"	132020025
4. Nylamid redondo tipo M 2" x 24"	RODILLO
5. Lamina C-11 48" x 120" (90 Kg/pieza) (2.25 Kgs/pie cuadrado)	GRPG

## Tensores

Descripción	Clave
6. Tensor metálico con varillas p/banda (fijo)	EBWH020
7. Tensor metálico p/banda (movil)	EB3820



6.



7.

## Tope



8.

Descripción	Clave
8. Tope de hule redondo p/puerta en caja seca Austin	B-1

## Tornillos

### Descripción

### Clave

- |     |  |            |
|-----|--|------------|
| 1.  | Tornillo de 7/8" x 4-1/2" p/balancin (6,000lbs)                        | 780        |
| 2.  | Tornillo de 9/16" x 3" p/muelles y balancines (2,000-3,500 lbs)        | KB3916     |
| 3.  | Tornillo de 9/16"x3-1/2" p/muelles y balancines (6,000 lbs) 175 p/caja | KB916312   |
| 4.  | Tornillo galvanizado de 3/16" x 3/4" punta de broca cabeza de cruz     | TPB316X34C |
| 5.  | Tornillo p/plataforma de 1/4" x 1-1/2" 2500 p/caja                     | TP14112    |
| 6.  | Tornillo p/plataforma de 1/4" x 2" 2000 p/caja                         | S 14214    |
| 7.  | Tornilo p/plataforma de 1/4" x 2-1/2" 1500 p/caja                      | T1/4X21/2  |
| 8.  | Tornilo p/plataforma de 1/4" x 2-1/4" 1500 p/caja                      | T14212     |
| 9.  | Tornillo punta broca 3/16" x 3/4" gal Estrella 5200 p/caja             | TPB316X34E |
| 10. | Tornillo y tuerca de centro para muelles                               | TTCM       |



	Descripción	Clave
1.	Tubo 2" hembra Towking p/barra 6" de largo	706009
2.	Tubo 2" hembra Towking p/barra 12" de largo	706010
3.	Tubo 2" hembra p/barra 12" de largo CURT	E-11
4.	Tubo 2" hembra p/barra 12" de largo 2.882 p/pza	RENYTH12
5.	Tubo 2" hembra p/barra 24" de largo CURT	E-13
6.	Tubo 2" hembra p/barra 6" de largo	RENYTH6
7.	Tubo 2" hembra p/barra 6" de largo CURT	E-9
8.	Tubo 2" hembra p/barra 9" de largo	RENYTH9
9.	Tubo 2" hembra p/barra 9" de largo CURT	E-10

## Tubos

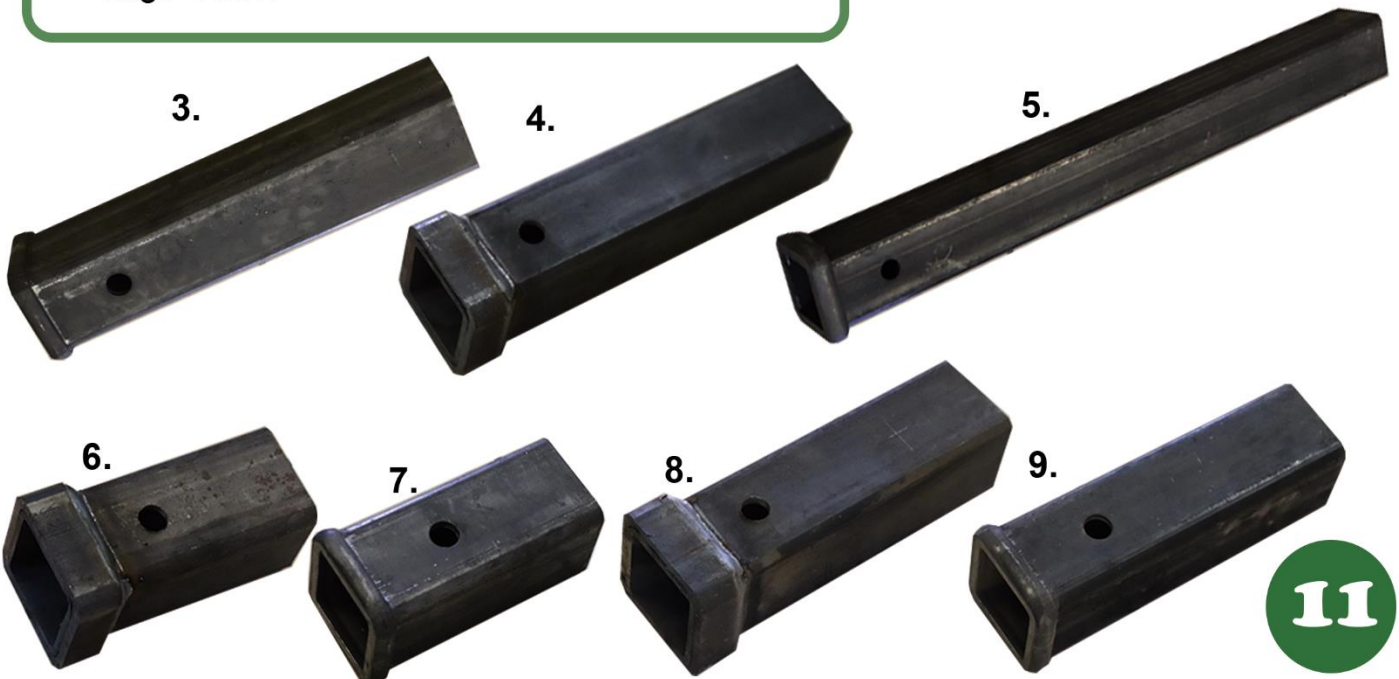
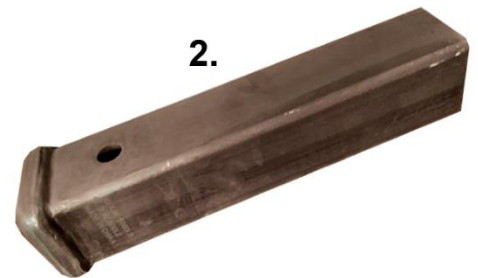

## Tuercas

	<b>Descripción</b>	<b>Clave</b>
1.	Tuerca candado 9/16" rosca fina liviana	T 9 16R
2.	Tuerca de 7/8" p/balancin (6,000lbs)	T7 8B
3.	Tuerca para grampas de 1/2"-20 rosca fina con flange	9000385



## Ventilador

	<b>Descripción</b>	<b>Clave</b>
4.	Ventilador p/remolque .32 # p/pza	24 003





# Accesorios para Ejes



[www.trailer.com.mx](http://www.trailer.com.mx)

## Ajustadores y Arandelas



	Descripción	Clave
1.	Ajustador p/balatas de 10,000 lbs	AJ10
2.	Ajustador p/balatas de 3,500 - 7,000lbs	043-004-00
3.	Anillo para rin doble rodado	35 52 1
4.	Arandela candado p/espiga de 1"	ARC
5.	Arandela p/espiga de 1"	A1
6.	Arandela p/espiga de 1-1/2"	SWO112



## Balatas

	Descripción	Clave
7.	Balata p/masa tambor 10,000 lbs (jgo c/dos balatas) derecha	6450060
8.	Balata p/masa tambor 10,000 lbs (jgo c/dos balatas) izquierda	6450059

# Accesorios para Ejes



## Baleros



### Descripción

### Clave

- |    |   |       |
|----|---|-------|
| 1. | Balero chico p/masa de 5 birlos<br>3,500 lbs  | 44649 |
| 2. | Balero chico p/masa de 6 birlos<br>5,200 lbs  | 15123 |
| 3. | Balero chico p/masa de 8 birlos<br>6,000 lbs  | 14125 |
| 4. | Balero grande p/masa de 5<br>birlos 3,500 lbs | 68149 |
| 5. | Balero grande p/masa de 8<br>birlos 6,000 lbs | 25580 |
| 6. | Balero p/masa chica de 2,000<br>lbs           | 44643 |
| 7. | Balero p/masa de 10,000 lbs                   | 387A  |

### Descripción

### Clave

- |     |   |         |
|-----|---|---------|
| 8.  | Birlo 1/2-13 x 1-1/2 union masa-<br>tambor 10,000 lbs Dexter (Linea<br>nueva 9-123) | 7700011 |
| 9.  | Birlo 9/16"   | B916    |
| 10. | Birlo p/masa de 10,000 lbs  | B10     |
| 11. | Birlo p/masa de 10,000 lbs<br>(ALKO)  | B10ALKO |
| 12. | Birlo p/masa de 3,500 lbs s/freno   | B35SF   |
| 13. | Birlo p/masa de 6,000 lbs c/freno   | B70CF   |
| 14. | Birlo p/masa de 6,000 lbs s/freno   | B60CF   |

## Birlos



## Espigas

	<b>Descripción</b>	<b>Clave</b>
1.	Espiga de 1-3/4" x 11" para 3,500 lbs	13411CA
2.	Espiga de 1-3/4" x 8" para 3,500 lbs	1348
3.	Espiga de 1-3/4" x 8-7/8" para 3,500 lbs con flange	SA351348
4.	Espiga de 2" x 8-7/8" para 3,500 lbs	2878
5.	Espiga de 2" x 8-7/8" para 3,500 lbs con flange	SA352878
6.	Espiga de 2-1/4" x 11" para 6,000 lbs	ESP6000
7.	Espiga de 2-1/4" x 11" para 6,000 lbs con flange	SA7017811
8.	Espiga para 2,000 lbs	E-C





# Accesorios para Ejes



## Frenos

Descripción	Clave
1. Freno hidráulico de 10,000 # derecho	23 411
2. Freno hidráulico de 10,000 # izquierdo	23 410
3. Freno p/sistema hidráulico de 10" derecha 5 birlos	23 313
4. Freno p/sistema hidráulico de 10" izquierda 5 birlos	23 312
5. Freno p/sistema hidráulico de 12" derecha 8 birlos	23 325
6. Freno p/sistema hidráulico de 12" izquierda 8 birlos	23 324
7. Freno plato derecho p/eje de 10 k #marca Al-Ko	FPDEALKO
8. Freno plato izquierdo p/eje de 10 k #marca Al-Ko	FPIZALKO
9. Freno plato c/balatas de 10" derecha de 5 birlos	23 27
10. Freno plato c/balatas de 10" izquierda 5 birlos	23 26
11. Freno plato c/balatas de 12" derecha 8 birlos 15 # p/pza	23 106
12. Freno plato c/balatas de 12" izquierda 8 birlos	23 105
13. Freno plato c/balatas p/masa de 10,000 lbs derecha (DEXTER)	23 196
14. Freno plato c/balatas p/masa de 10,000 lbs izquierda (DEXTER)	23 195



1 y 2.



3 y 4.



5 y 6.

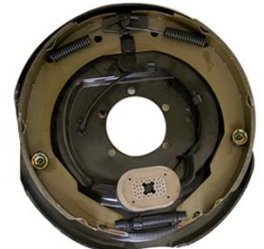

7 y 8.

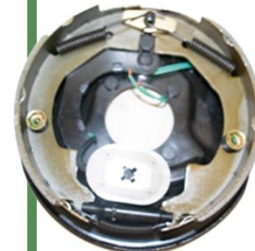

9 y 10.



11 y 12.



13 y 14.

# Accesorios para Ejes

## Grampas

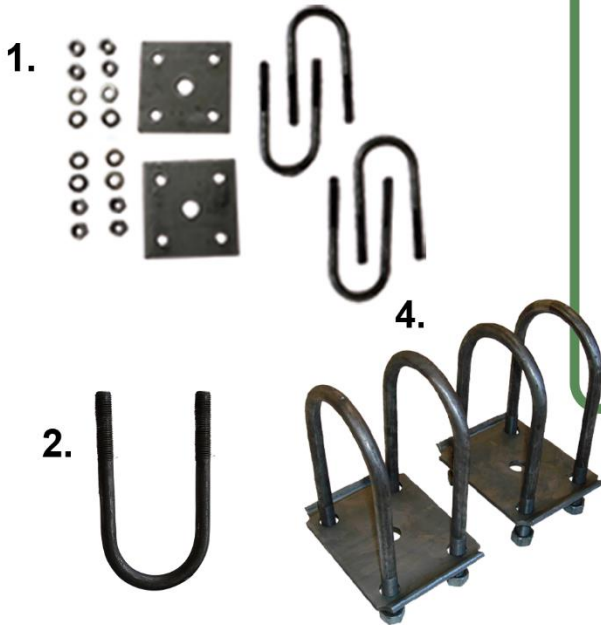

### Descripción

### Clave

- |    |                             |        |
|----|-----------------------------|--------|
| 1. | Grampas de 2,000 lbs (jgo)  | 4205N  |
| 2. | Grampa para 3,500 lbs       | G 3N   |
| 3. | Grampas de 3,500 lbs (jgo)  | 4202N  |
| 4. | Grampas de 6,000 lbs (jgo)  | 4201N  |
| 5. | Grampas de 10,000 lbs (jgo) | 11 77N |

## Magnetos

### Descripción

### Clave

- |     |  |              |
|-----|--|--------------|
| 6.  | Magneto p/freno de 10,000 lbs (AL-KO)  | MA10         |
| 7.  | Magneto p/freno de 10,000 lbs (DEXTER) | 71 106       |
| 8.  | Magneto p/freno de 3,500 lbs           | 876983000203 |
| 9.  | Magneto p/freno de 6,000 lbs           | 876983000210 |
| 10. | Candado p/magneto de 10,000 lbs        | 027-050-00   |
| 11. | Candado p/magneto de 3,500-7,000 lbs   | 27-9         |

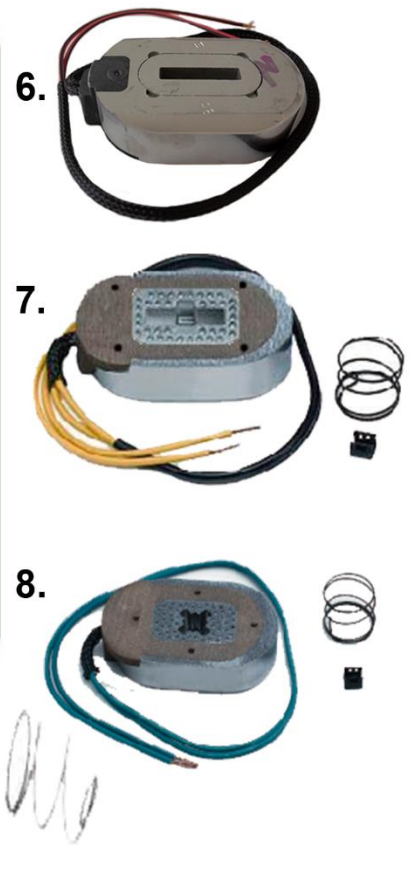

# Accesorios para Ejes



## Descripción

## Clave

- |     |   |          |
|-----|---|----------|
| 1.  | Masa de 5 birlos (2,000 lbs)<br>s/espiga s/freno                  | 88545    |
| 2.  | Masa 5 birlos chevy (3,500 lbs)<br>s/espiga s/freno               | M C      |
| 3.  | Masa 5 birlos chevy (3,500 lbs)<br>s/freno                        | M D      |
| 4.  | Masa de 5 birlos ford (3,500 lbs)<br>s/freno                      | M F      |
| 5.  | Masa de 6 birlos (3,500 lbs)<br>s/espiga s/freno                  | M84655   |
| 6.  | Masa tambor de 5 birlos chevy<br>(3,500 lbs) s/espiga p/freno     | 8 249 91 |
| 7.  | Masa tambor de 5 birlos dodge<br>(3,500 lbs) s/espiga p/freno     | 8 247 90 |
| 8.  | Masa tambor de 5 birlos ford<br>(3,500 lbs) s/espiga p/freno      | 8 255 91 |
| 9.  | Masa tambor de 6 birlos (3,500 lbs)<br>s/espiga p/freno           | MT635    |
| 10. | Masa de 6 birlos (6,000 lbs)<br>s/espiga s/freno                  | M 6      |
| 11. | Masa de 8 birlos (6,000 lbs)<br>s/espiga s/freno                  | M 8      |
| 12. | Masa tambor de 6 birlos (6,000 lbs)<br>s/espiga p/freno           | MT6      |
| 13. | Masa tambor de 8 birlos (6,000 lbs)<br>s/espiga p/freno 42.1      | 8 201 91 |
| 14. | Masa de 8 birlos (10,000 lbs)<br>p/eje dexter                     | M10K     |
| 15. | Masa de 8 birlos (10,000 lbs)<br>p/eje dexter (Linea Nueva 9-123) | 7650242  |

## Masas



## Tambores

	Descripción	Clave
1.	Tambor p/masa de 10,000 lbs DEXTER 47.2 # p/pza	T10K
2.	Tambor p/masa de 10,000 lbs DEXTER Línea Nueva 9-123	7650243



## Retenes

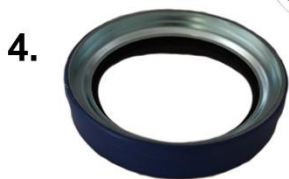

	Descripción	Clave
3.	Retén SKF	370065A
4.	Retén p/masa de 10,000 lbs ALKO	R10ALKO
5.	Retén p/masa de 10,000 lbs (DEXTER)	10 50
6.	Retén p/masa de 15,000 lbs	10-56
7.	Reten p/masa de 2,000 lbs 5 birlos	34823
8.	Retén p/masa de 3,500 lbs 5 birlos	R M
9.	Retén p/masa de 6,000 lbs 8 birlos	R 6

# Accesorios para Ejes



## Soportes

### Descripción

### Clave

- |    |   |     |
|----|---|-----|
| 1. | Soporte de eje p/sujetar el muelle (2,000 lbs) .7 # p/pza | S2N |
| 2. | Soporte de eje p/sujetar el muelle (3,500 lbs) .7 # p/pza | S3N |
| 3. | Soporte de eje p/sujetar el muelle (6,000 lbs)            | S6N |
| 4. | Soporte guía para cámara de perico 80                     | 767 |

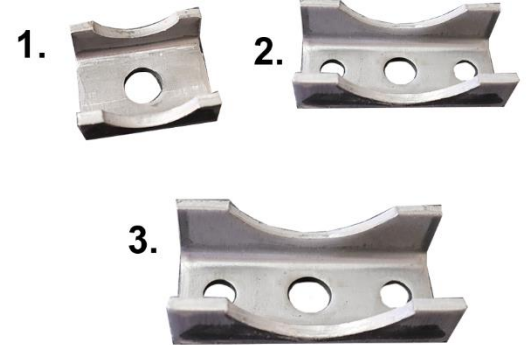

## Tapa p/masa

### Descripción

### Clave

- |     |  |         |
|-----|--|---------|
| 5.  | Tapa p/masa 10,000 lbs de plástico ALKO    | T10ALKO |
| 6.  | Tapa p/masa 10,000 lbs de plástico DEXTER  | T-10    |
| 7.  | Tapa p/masa 10,000 lbs de plástico Quality | T-10Q   |
| 8.  | Tapa p/masa de 2,000-3,500 lbs             | T M     |
| 9.  | Tapa p/masa de 2,000-3,500 lbs c/hule      | 469001  |
| 10. | Tapa p/masa de 5,200 lbs                   | T65200  |
| 11. | Tapa p/masa de 5,200 lbs                   | 469002  |
| 12. | Tapa p/masa de 7,000 lbs                   | T 6     |
| 13. | Tapa p/masa de 7,000 lbs c/hule            | 469003  |

## Taza p/masa

Descripción	Clave
1. Taza p/balero chico 3,500 lbs	T35
2. Taza p/balero chico 6,000 lbs	14276
3. Taza p/balero grande 3,500 lbs	T35G
4. Taza p/balero grande 6,000 lbs	T25580



## Tuercas



Descripción	Clave
5. Tuerca galvanizada de 1/2" cónica p/birlo de masa	6 80
6. Tuerca galvanizada de 5/8" cónica p/birlo de masa	6 109
7. Tuerca galvanizada de 9/16" cónica p/birlo de masa	LN 916
8. Tuerca p/espiga de 1"	T-1E
9. Tuerca p/birlo de 10,000 lbs	TU10
10. Tuerca p/birlo de 10,000 lbs ALKO	TU10ALKO

# Accesorios de Arrastre



## Barras

Descripción	Clave
1. Barra 2" c/3 bolas cromadas 1-7/8", 2", 2-5/16" CURT	D-155
2. Barra 2" c/3 bolas 1-7/8", 2", 2-5/16" CURT	D-150
3. Barra 1-1/4" drop 1-1/4" CURT	D-18
4. Barra 1-1/4" drop 3-1/4" (3,500 lbs) CURT	D-21
5. Barra 2" Adaptador Pintle Mounts (10,000 lbs) CURT	E-23
6. Barra 2" ajustable a 13" 5,000 lbs	75120
7. Barra 2" drop (6,000 lbs)	RENYD3
8. Barra 2" drop (6,000 lbs) CURT	D-3
9. Barra 2" drop 2" c/pasador y bola 8.7 # p/pza	1803307
10. Barra 2" drop 2" cromada (6,000 lbs) CURT	D-45
11. Barra 2" drop 3" ajustable c/2 bolas cromadas 1-7/8", 2" B&W	TS10035B

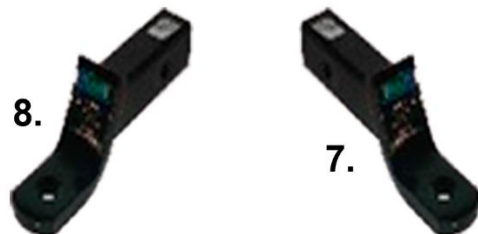
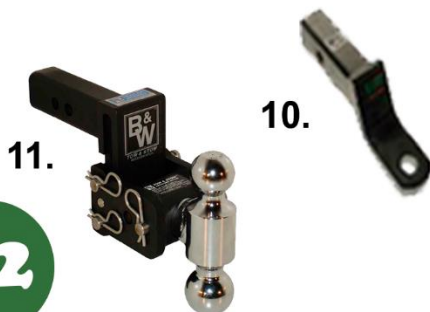
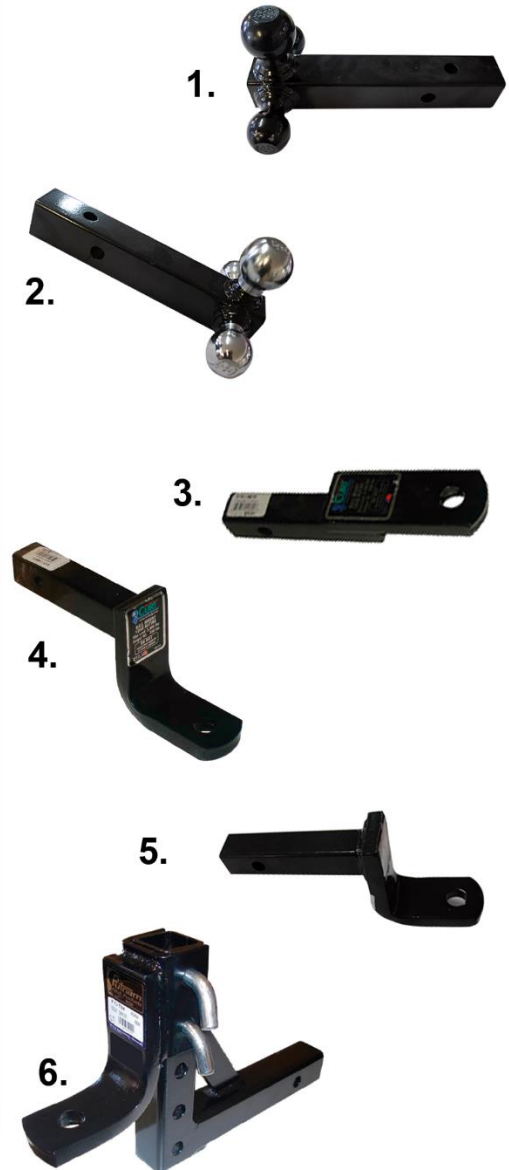



# Accesorios de Arrastre



## Barras

	Descripción	Clave
1.	Barra 2" drop 3" ajustable c/2 bolas cromadas 2", 2-5/16" B&W	TS10033B
2.	Barra 2" drop 3" ajustable c/3 bolas cromadas 1-7/8", 2", 2-5/16" B&W	TS10047B
3.	Barra 2" drop 4" (6,000 lbs) CURT	D-5
4.	Barra "2 drop 4" x 10-1/4" (6,000 lb) CURT	D-6
5.	Barra 2" drop 4" x 12-1/4" (6,000 lbs) CURT	D-27
6.	Barra 2" drop 5" ajustable c/2 bolas cromadas 2", 2-5/16" B&W	TS10037B
7.	Barra 2" drop 6" (6,000 lbs) CURT	D-7
8.	Barra 2" drop 8" (5,000 lbs) CURT	D-9
9.	Barra Towking 2" Adaptador Pintle Mounts 6 posiciones 10,000 lbs	712003

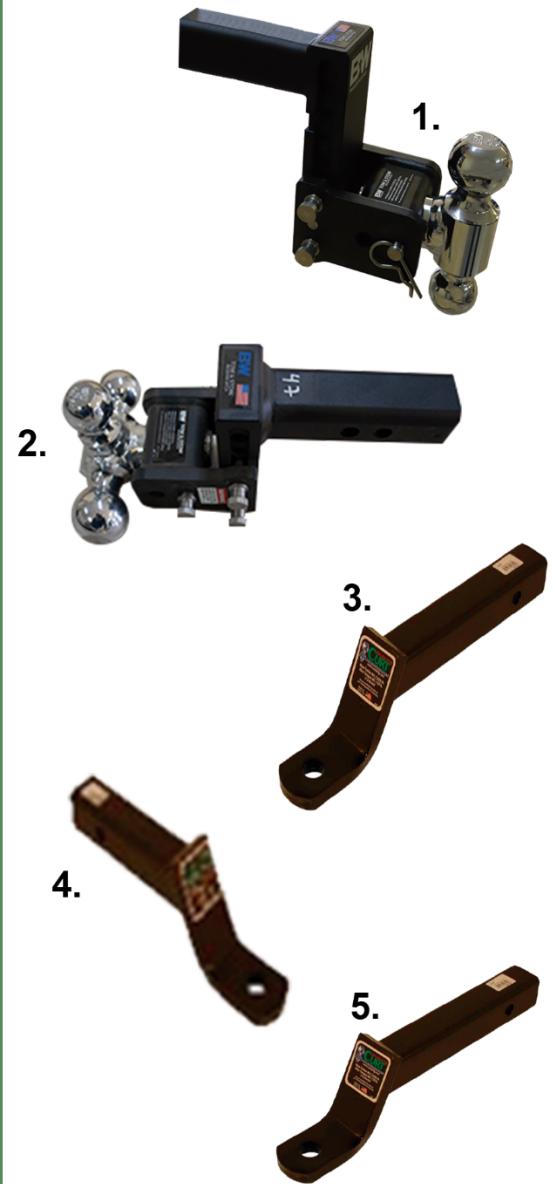

## Barras

### Descripción

### Clave

- |    |   |        |
|----|---|--------|
| 1. | Barra Towking 2" drop 2" (6,000 lbs)                    | 705000 |
| 2. | Barra Towking 2" drop 6" (6,000 lbs)                    | 705003 |
| 3. | Barra adaptador de 1-1/4" a 2" CURT                     | D-185  |
| 4. | Barra Towking 2" c/3 bolas cromadas 1-7/8", 2", 2-5/16" | 705008 |

1.



2.



3.



4.

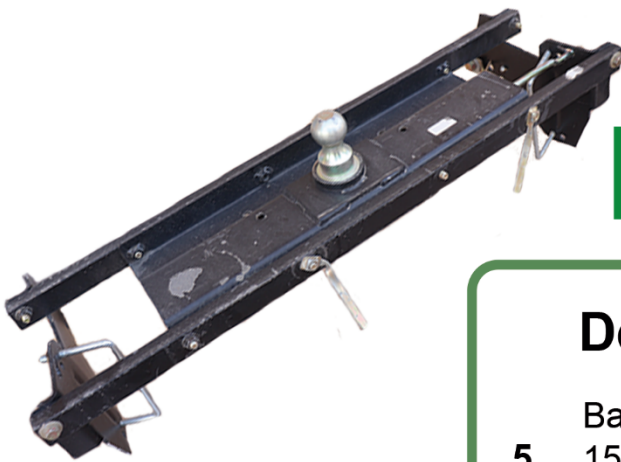

## Base p/bola

### Descripción

### Clave

- |    |  |       |
|----|--|-------|
| 5. | Base p/bola escondida Dodge 1500, 2500, 3500, MegaCab 02-08 CURT | C-655 |
| 6. | Base p/bola escondida Dodge 94-01 CURT                           | C-635 |
| 7. | Base p/bola escondida Ford F-150 04-08 CURT                      | C-641 |
| 8. | Base p/bola escondida Ford F-150, 250 97-03 CURT                 | C-637 |

# Accesorios de Arrastre



## Base p/bola



	Descripción	Clave
1.	Base p/bola escondida Ford F-150, 250, 350 80-96 CURT	C-636
2.	Base p/bola escondida Ford F-250, 350SD, 450SD 99-09 CURT	C-643
3.	Base p/bola escondida Nissan Titan 04-09 CURT	C-664
4.	Base p/bola escondida Toyota Tundra 07-09 CURT	C-667

## Kit base y bola escondida

	Descripción	Clave
5.	Kit de base y bola escondida Chevrolet & GMC 3/4 y 1 ton. 11-15	GNRK 1012
6.	Kit de base y bola escondida Chevrolet & GMC 1/2 ton. Short Bed Only 07-17 B&W	GNRK 1057
7.	Kit de base y bola escondida Chevrolet Duramax & GMC 3/4 ton. 01-10, 1 ton. 07-10 B&W	GNRK 1067



## Kit base y bola escondida

Descripción	Clave
1. Kit de base y bola escondida Dodge 1 ton. 13-17 B&W	GNRK 1314
2. Kit de base y bola escondida Dodge 1/2 ton. 09-17 B&W	GNRK 1309
3. Kit de base y bola escondida Dodge 1/2 Ton. 94-01, 3/4 y 1 Ton. 94-02 B&W	GNRK 1394
4. Kit de base y bola escondida F250, F350 y F450 4x2 Super Duty 2017 B&W	GNRK 1116
5. Kit de base y bola escondida F250, F350 y F450 4x4 Super Duty 17-18 B&W	GNRK 1117
6. Kit de base y bola escondida Ford 3/4 y 1 ton. Super Duty 11-16, F450 11-16 B&W	GNRK 1111
7. Kit de base y bola escondida Toyota Tundra All Beds 07-17 B&W	GNRK 1257
8. Kit de base y bola escondida Chevrolet & GMC 1/2 y 3/4 ton. 99-07 B&W	GNRK 1059
9. Kit de base y bola escondida Chevrolet & GMC 1/2, 3/4 y 1 ton. Long Bed 88-00 B&W	GNRK 1000
10. Kit de base y bola escondida Chevrolet & GMC 1/2, 3/4 y 1 ton. Short Bed 88-00 B&W	GNRK 1050

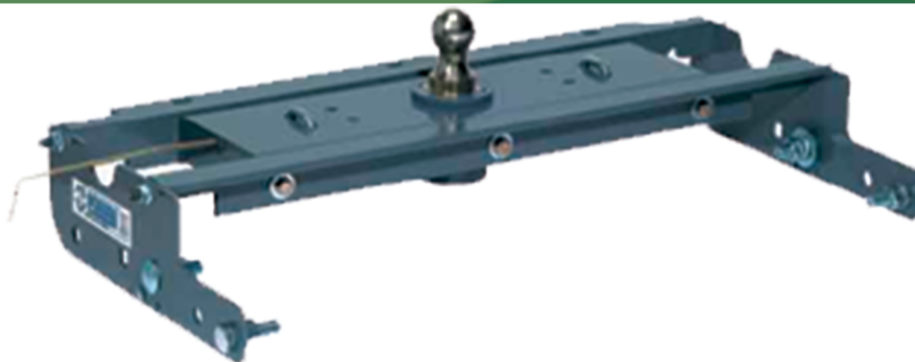

# Accesorios de Arrastre



## Kit base y bola escondida

### Descripción

### Clave

- |   |           |
|---|-----------|
| 1. Kit de base y bola escondida Dodge 3/4 ton. 14-18 B&W                            | GNRK 1384 |
| 2. Kit de base y bola escondida Dodge 1/2 Ton. 94-01, 3/4 y 1 Ton. 94-02 B&W        | GNRK 1310 |
| 3. Kit de base y bola escondida Ford 1/2 y 3/4 ton. 97--03 B&W                      | GNRK 1197 |
| 4. Kit de base y bola escondida Ford 3/4 y 1 ton. 80-98 B&W                         | GNRK 1100 |
| 5. Kit de base y bola escondida Ford 3/4 y 1 ton. Super Duty 99-110, F450 08-10 B&W | GNRK 1108 |
| 6. Kit de base y bola escondida Nissan Titan Short Bed 04-08 B&W                    | GNRK 1204 |
| 7. Bola escondida 2-5/16" curt  | C-52      |



# Ejes



## Ejes normales de 2,000 - 7,000 lbs

Descripción	Clave
1. Eje normal 2,000 lbs	2048
2. Eje normal 2,000 lbs	20855
3. Eje normal 3,500 lbs, 550, Espiga con Flange Cambered, EZ Lube, Sin frenos	3580S
4. Eje normal 3,500 lbs, 550, Espiga con Flange Cambered, EZ Lube, Frenos elec.	3580C
5. Eje normal 3,500 lbs, 550, Espiga con Flange, Cambered, EZ Lube, Sin frenos, Muelle de 4 hojas	E35805550SF
6. Eje normal 3,500 lbs, 550, Espiga con Flange, Cambered, EZ Lube, Frenos elec., Muelle de 4 hojas	E35805550CF
7. Eje normal 5,200 lbs, 550, Espiga con Flange, Cambered, EZ Lube, Sin frenos	5280S
8. Eje normal 5,200 lbs, Espiga con Flange, Cambered, EZ Lube, Frenos elec.	5280C
9. Eje normal 5,200 lbs, Espiga con Flange, Cambered, EZ Lube, Sin frenos, Muelle de 5 hojas	E52806550SF
10. Eje normal 5,200 lbs, Espiga con Flange, Cambered, EZ Lube, Frenos elec, Muelle de 5 hojas	E52806550CF
11. Eje normal 7,000 lbs, Espiga con Flange, Cambered, EZ Lube, Sin frenos	7080S
12. Eje normal 7,000 lbs, Espiga con Flange, Cambered, EZ Lube, Frenos elec,	7080C
13. Eje normal 7,000 lbs, Espiga con Flange, Cambered, EZ Lube, Sin frenos, Muelle de 6 hojas	E70808650SF
14. Eje normal 7,000 lbs, Espiga con Flange, Cambered, EZ Lube, Frenos elec, Muelle de 6 hojas	E70808650CF

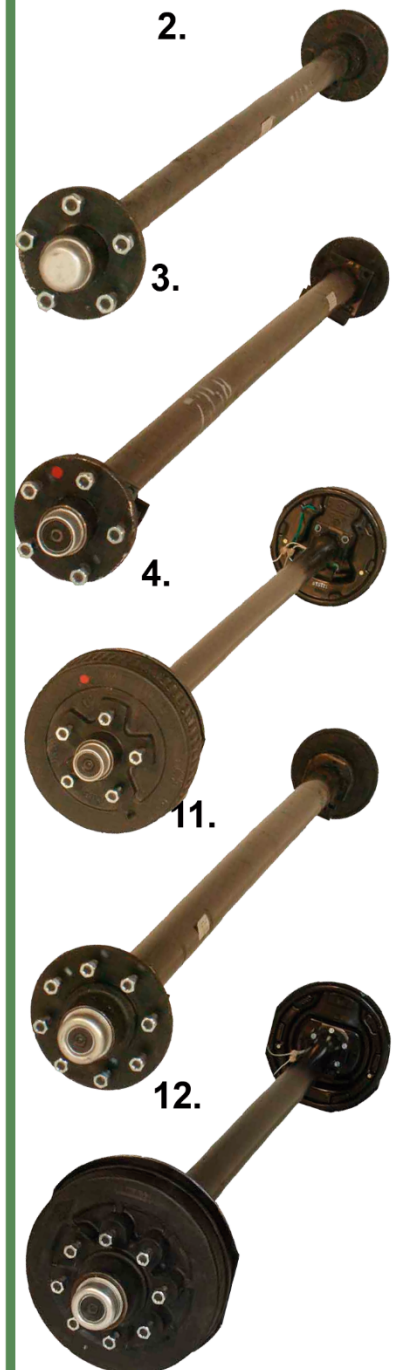

\* Las claves pueden variar dependiendo de las medidas del eje

## Ejes drop de 3,500 - 7,000 lbs

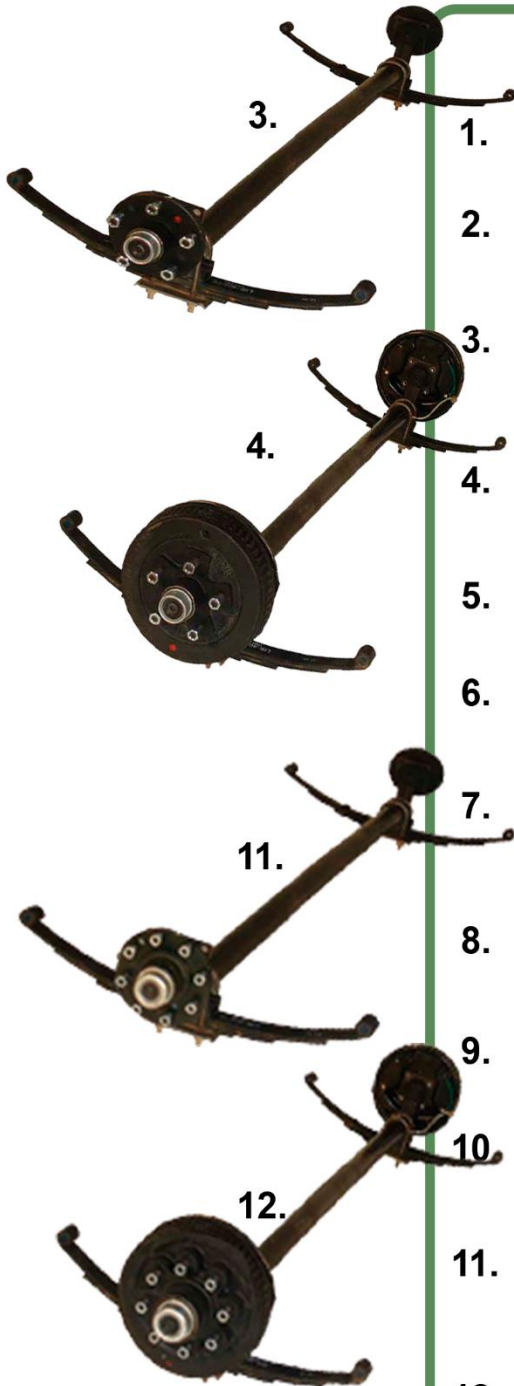

	<b>Descripción</b>	<b>Clave</b>
1.	Eje drop de 3,500 lb, 550, Espiga con Flange, Cambered, EZ Lube, Sin frenos	ED3580S
2.	Eje drop de 3,500 lb, 550, Espiga con Flange, Cambered, EZ Lube, Frenos elec.	ED3580C
3.	Eje drop de 3,500 lb, 550, Espiga con Flange, Cambered, EZ Lube, Sin frenos, Muelle de 4 hojas	ED35805550SF
4.	Eje drop de 3,500 lb, 550, Espiga con Flange, Cambered, EZ Lube, Frenos elec, Muelle de 4 hojas	ED35805550CF
5.	Eje drop de 5,200 lb, 550, Espiga con Flange, Cambered, EZ Lube, Sin frenos	ED5280S
6.	Eje drop de 5,200 lb, 550, Espiga con Flange, Cambered, EZ Lube, Frenos elec.	ED5280C
7.	Eje drop de 5,200 lb, 550, Espiga con Flange, Cambered, EZ Lube, Sin frenos, Muelle de 5 hojas	ED52806550SF
8.	Eje drop de 5,200 lb, 550, Espiga con Flange, Cambered, EZ Lube, Frenos elec, Muelle de 5 hojas	ED52806550CF
9.	Eje drop de 7,000 lb, 550, Espiga con Flange, Cambered, EZ Lube, Sin frenos	ED7080S
10.	Eje drop de 7,000 lb, 550, Espiga con Flange, Cambered, EZ Lube, Frenos elec.	ED7080C
11.	Eje drop de 7,000 lb, 550, Espiga con Flange, Cambered, EZ Lube, Sin frenos, Muelle de 6 hojas	ED52806550SF
12.	Eje drop de 7,000 lb, 550, Espiga con Flange, Cambered, EZ Lube, Frenos elec, Muelle de 6 hojas	ED52806550CF



## Ejes Sin Masas

### Descripción

1. Eje de 3,500 lb, Espiga con Flange, Cambered, EZ Lube
2. Eje drop de 3,500 lb, Espiga con Flange, Cambered, EZ Lube
3. Eje de 5,200 lb, Espiga con Flange, Cambered, EZ Lube
4. Eje drop de 5,200 lb, Espiga con Flange, Cambered, EZ Lube
5. Eje de 7,000 lb, Espiga con Flange, Cambered, EZ Lube
6. Eje drop de 7,000 lb, Espiga con Flange, Cambered, EZ Lube

### Clave

1.

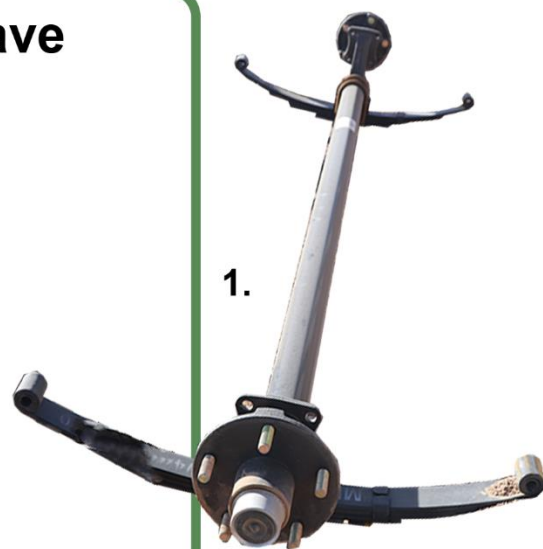

2.



6.



\* Las claves pueden variar dependiendo de las medidas del eje

## Ejes Torflex 4" 3,500 - 7,000 lbs Grado UP s/freno



13.

### Descripción

- 10. Eje Torflex 3,500 lbs 60.5" 22.5°
- 11. Eje Torflex 3,500 lbs 69.5" 22.5°
- 12. Eje Torflex 3,500 lbs 72" 22.5°
- 13. Eje Torflex 3,500 lbs 79.5" 22.5°

### Clave

- TFC35617422UI
- ET356722GUSF
- ET357222GUSF
- TFC35799222UI

## Ejes Torflex 4" 3,500 - 7,000 lbs Grado UP c/freno

### Descripción

- 1. Eje Torflex 3,500 lbs 60.5" 22.5°
- 2. Eje Torflex 3,500 lbs 69.5" 22.5°
- 3. Eje Torflex 3,500 lbs 72" 22.5°
- 4. Eje Torflex 3,500 lbs 79.5" 22.5°
- 5. Eje Torflex 7,000 lbs 60.5" 22.5°
- 6. Eje Torflex 7,000 lbs 69.5" 22.5°
- 7. Eje Torflex 7,000 lbs 72" 22.5°
- 8. Eje Torflex 7,000 lbs 78.5" 22.5°
- 9. Eje Torflex 7,000 lbs 80" 22.5°

### Clave

- TFC35617422UE
- ET356722GUCF
- ET357222GUCF
- TFC35799222UE
- ET706022GUCF
- ET706722GUCF
- ET707222GUCF
- ET707822GUCF
- ET708022GUCF



7.

## Ejes Dexter 10,000 lbs



10.

### Descripción

- 10. Eje Dexter 10,000 lbs c/freno hidráulico, muelles y grampas

### Clave

- E10000CFH

# Eléctricos



## Adaptadores para enchufes

Descripción	Clave
1. Adaptador de 6 y 4 puntas	52910
2. Adaptador de 7 a 6 y 4 puntas Hoppy	47565
3. Adaptador de 7 y 4 puntas	52900
4. Adaptador de 7 y 6 puntas	53052
5. Adaptador de enchufe de 6 a 4 puntas	34804
6. Adaptador multiple de 7 a 4 puntas	ADAP M7X4



## Adaptador p/control de freno



Descripción	Clave
7. 2017 Chevrolet Silverado 2500HD CURT	51451
8. 03-06 Chevy/GM standar CURT	I-2035
9. 03-11 Toyota standar CURT	I-2036
10. 04-13 Nissan Titan modular	30514
11. 07-09 GM modular	30520
12. 09-18 Ford CURT	51437
13. 10, 11, 12 y 15 Dodge CURT	51439
14. 13 y 14 Dodge CURT	51453
15. 92-08 Ford modular	30500
16. 95-09 Dodge standar CURT	I-2033
17. 97-08 Ford standar CURT	I-2032

## Arneses



### Descripción

### Clave

1.	Adaptador de 4 a 6 puntas	30601
2.	Adaptador de 4 a 7 puntas	30603
3.	Original Ford 2017 5ta rueda 2.1 mts CURT	57008
4.	Original Ford/GM/Chevy/Dodge/ Nissan/Ram/Toyota 5ta rueda 3.0 mts CURT	56000
5.	Original 00-Current GM Full size SUV's & Pickups	30064
6.	Original 02-06 Dodge Full size Ram Pickups	30015
7.	Original 03-05 Nissan Murano CURT	55571
8.	Original 03-09 GM Vans	30158
9.	Original 04-07 Dodge, Chrysler Mini Vans	30018
10.	Original 05-15 Toyota Tacoma Curt	55513
11.	Original 07-09 Dodge Nitro	30150

## Arneses



	Descripción	Clave
1.	Original 16-17 Toyota Tacoma CURT	56282
2.	Original 91-95 Chrysler Mini Vans	30080
3.	Original 95-03 Dodge Ram Pickups	30014
4.	Original 96-00 Chrysler Mini Vans	30016
5.	Original 97-03 Ford Light Duty Pickups	30145
6.	Original 99-03 Ford Full size Vans	30005
7.	Original 99-05 Dodge Pickups	30078
8.	Original 99-07 Ford/GM	30027
9.	Original 04-07 Dodge, Chrysler Mini Vans	30018
10.	Original Honda Pilot 03-08 CURT	55336
11.	Original Honda Pilot 16-17 CURT	56291
12.	Original Toyota Highlander 08-11 CURT	56034
13.	Original Toyota Highlander 08-17 CURT	56217
14.	Original de 7 y 4 puntas CURT	55774



## Bases metálicas

Descripción	Clave
1. P/enchufe de 4 puntas CURT	32437
2. P/enchufe de 6 puntas CURT	57207
3. P/enchufe de 7 puntas CURT	I-23

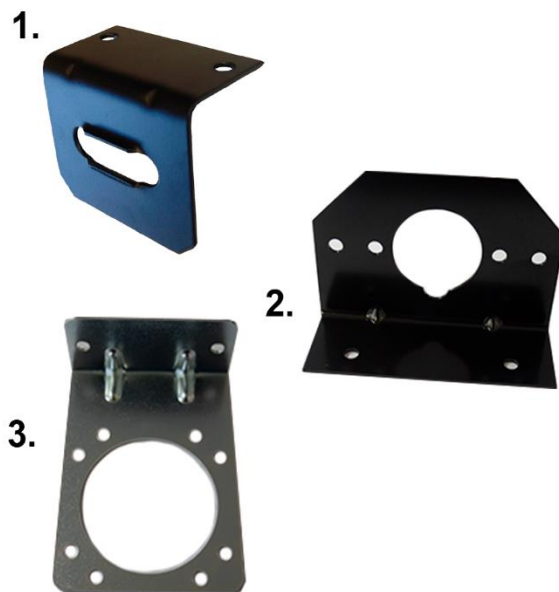

## Cable C-16

Descripción	Clave
4. De 1 hilo C-16 amarillo	16AM
5. De 1 hilo C-16 azul	16A
6. De 1 hilo C-16 blanco	16B
7. De 1 hilo C-16 café	16C
8. De 1 hilo C-16 negro	16N
9. De 1 hilo C-16 rojo	16R
10. De 1 hilo C-16 verde	16V
11. De 1 hilo C-16 azul	16A
12. De 1 hilo C-16 blanco	16B

## Cable uso rudo

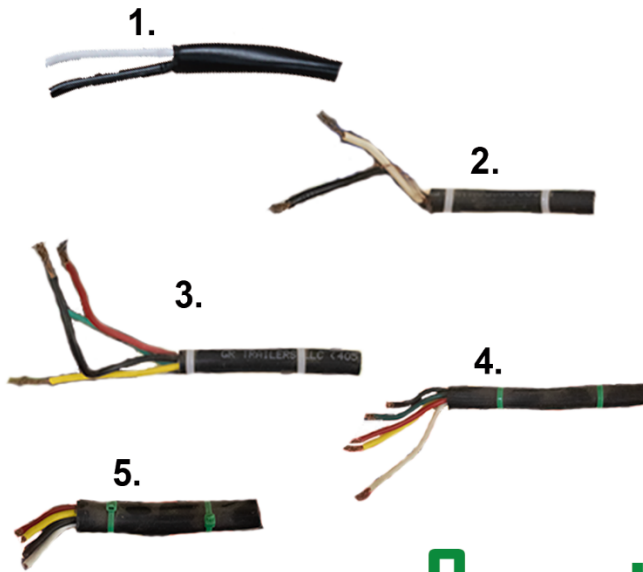

Descripción	Clave
1. 2 hilos C-18	CUR2
2. 3 hilos C-18	CUR3
3. 4 hilos C-18	CUR4
4. 5 hilos C-18	CUR5
5. 7 hilos C-18	CUR7

## Conectores eléctricos

Descripción	Clave
6. Conector eléctrico para remolque	564

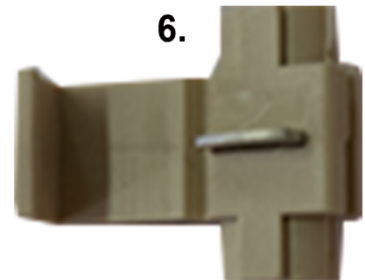

## Control de freno

Descripción	Clave
7. Voyager	9030
8. Discovery	51120
9. Venturer	51110
10. Spectrum Curt	51170



## Convertidor de luces

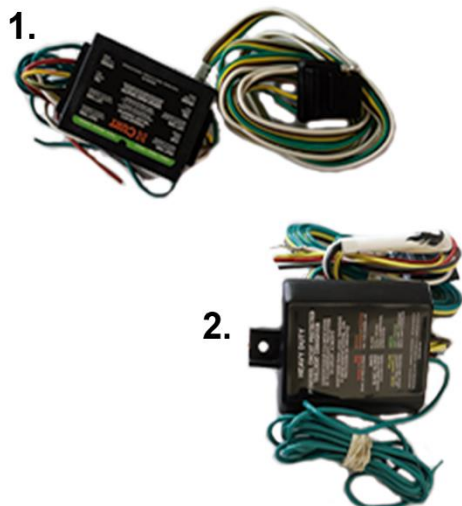

## Enchufes

### Descripción

### Clave

- |   |       |
|---|-------|
| 1. Convertidor de luces CURT                | 56130 |
| 2. Convertidor de luces Multi Function CURT | 59236 |
| 3. Convertidor de luces Powered CURT        | 59190 |

### Descripción

### Clave

- |   |         |
|---|---------|
| 4. Enchufe conector hule 4 puntas                   | 5410    |
| 5. Enchufe conector hule 4 puntas Towing de 25 pies | 7510HS2 |
| 6. Enchufe conector hule 4 puntas Towing            | 7510HS1 |
| 7. Enchufe de 7 puntas hembra                       | E7H     |
| 8. Enchufe de 7 puntas macho                        | E7M     |
| 9. Enchufe metálico 4 puntas hembra                 | E4H     |
| 10. Enchufe metálico 4 puntas macho                 | E4M     |
| 11. Enchufe metálico 6 puntas hembra                | E E     |
| 12. Enchufe metálico 6 puntas macho                 | E M     |
| 13. Enchufe metálico 7 puntas macho                 | EM7M    |

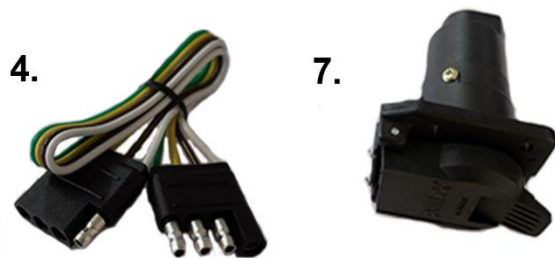

## Interruptor



### Descripción

1. Interruptor p/freno sistema de frenado

### Clave

BASP

## Sistema de Frenado

### Descripción

2. Sistema de frenado c/kit

### Clave

20100



## Sistema Electro-hidráulico

3.



### Descripción

3. Unidad electro hidráulica para freno de eje hidráulico

### Clave

UEPFH

# Fenders



## Fender p/remolque lámina lisa

### Descripción

### Clave

- |    |   |         |
|----|---|---------|
| 1. | Fender 9" x 72" - 2 ejes (salpicadera)  | 2122    |
| 2. | Fender 9" x 32" - 1 eje (salpicadera)   | 2105    |
| 3. | Fender 7"x28" - 1 eje (salpicadera)     | 2304    |
| 4. | Fender de 10 3/4"x108" 3 ejes           | 2142    |
| 5. | Fender 9" x 108" - 3 ejes (salpicadera) | 7050049 |

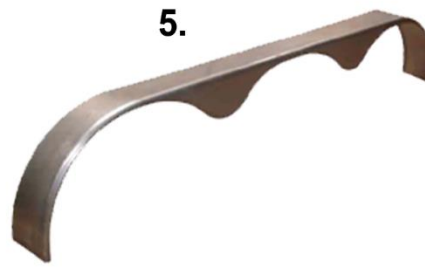

## Fender p/remolque lámina antiderrapante

### Descripción

### Clave

- |    |                                       |         |
|----|---------------------------------------|---------|
| 6. | Fender 9"x108" - 3 ejes (salpicadera) | 7050050 |
| 7. | Fender 9"x32" - 1 eje (salpicadera)   | 2105 T  |
| 8. | Fender 9"x72" - 2 ejes (salpicadera)  | 2122 T  |



## Fender p/remolque lámina aluminio lisa



### Descripción

### Clave

- |   |        |
|---|--------|
| 1. Fender 10-3/4" x 72" - 2 ejes C-14 (salpicadera) | F1072A |
| 2. Fender de aluminio liso de 2 ejes                | FAL2   |
| 3. Fender delantero de 128"                         | FA128  |

## Fender p/remolque lámina aluminio antiderapante

### Descripción

### Clave

- |   |         |
|---|---------|
| 4. Fender de 7"x28" - 1 eje C-14                | 2304 AT |
| 5. Fender 9"x32" -1 eje (salpicadera)           | 2105 AT |
| 6. Fender de 9"x72" - 2 ejes C-14 (salpicadera) | 2122 AT |

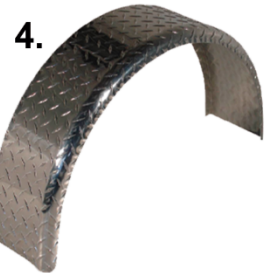

## Estribos p/remolque lámina alum. ant.

Descripción	Clave
1. P/caja seca 4008 lam. alum. ant. c-14	EPCS4008
2. P/caja seca 5008/6010 lam. alum. ant. c-14	EPCS5008-6010
3. P/caja seca 6012 lam. alum. ant. c-14	EPCS6012

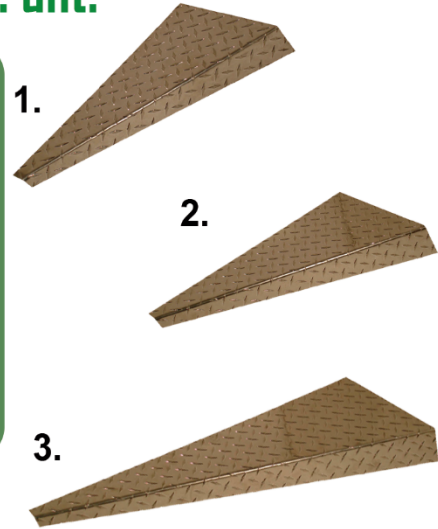

## Liner para Fender

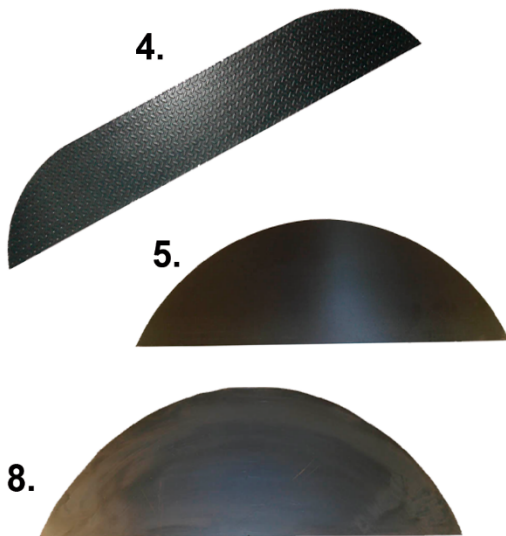

Descripción	Clave
4. Liner 12" p/fender de 9" x 72" lamina antiderrapante C-14	L2122A
5. Liner 12" p/fender de 9" x 32" C-18	L2105
6. Liner 12" p/fender 9" x 72" C-18	L2122
7. Liner 12-1/2" p/fender 9" x 72" C-18	L2123
8. Liner p/fender 7" x 28"	L2304

## Tapas

Descripción	Clave
9. Tapa p/rampa normal con solerita y varilla	TPRN
10. Tapa p/lancha con grasera de 3,500 lbs CURT	F-198



## Estribos p/remolque lámina lisa

### Descripción

### Clave

- |   |         |
|---|---------|
| 1. Delantero p/cama baja 4007-4008 lam. c-14 8"x7.25" | ED87    |
| 2. Delantero p/cama baja 5010 lam. c-14 9.25"x11.125" | ED911   |
| 3. Delantero p/cama baja 7016 lam. c-14 9.5"x18"      | ED9518  |
| 4. Delantero p/ganadero 5014 lam. c-14 9.5"x38.5"     | ED95385 |
| 5. Delantero p/ganadero 5016 lam. c-14 9.5"x52.25"    | ED9552  |
| 6. Trasero p/cama baja 4007-4008 lam. c-14 8"x7.25"   | ET87    |
| 7. Trasero p/cama baja 5010 lam. c-14 9.25"x11.125"   | ET911   |
| 8. Trasero p/cama baja 7016 lam. c-14 9.5"x21"        | ET9521  |
| 9. Trasero p/ganadero 5014 lam. c-14 9.5"x21.5"       | ET95215 |
| 10. Trasero p/ganadero 5016 lam. c-14 9.5"x31.25"     | ET9531  |

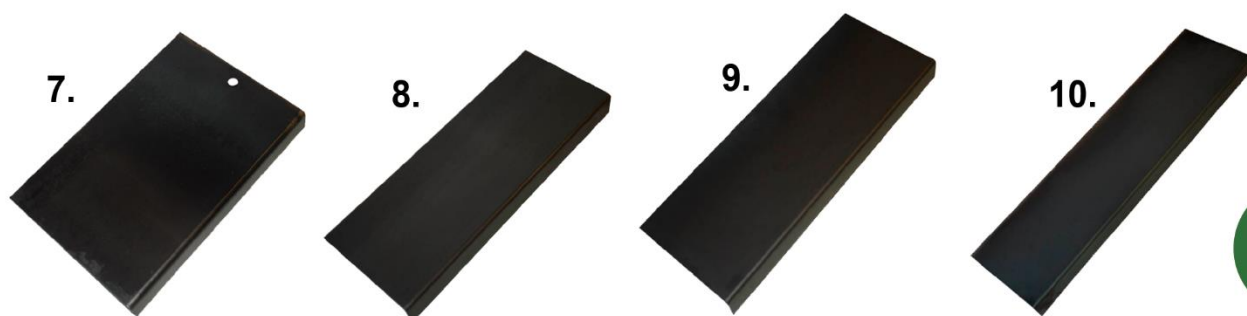
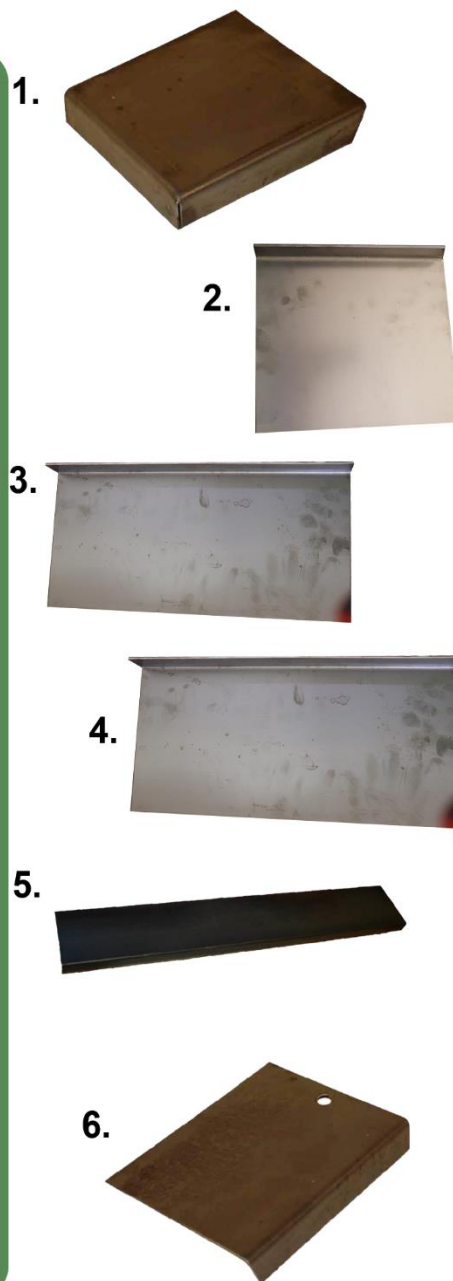



# Gatos



[www.trailer.com.mx](http://www.trailer.com.mx)



## Gatos mecánicos Bulldog



Descripción	Clave
1. Gato mec. Bulldog 2,000 lbs abatible con base	TWS 151 DS
2. Gato mec. Bulldog K-10 10,000 lbs	182415
3. Gato mec. Bulldog corto c/tubo palanca arriba 2,000 lbs	158451
4. Gato mec. Bulldog corto c/tubo palanca al lado 2,000 lbs	5WS158DTSF
5. Gato mec. Bulldog largo c/tubo palanca arriba 2,000 lbs	158452
6. Gato mec. Bulldog palanca arriba 5,000 lbs	783192011718

## Gato Norte

Descripción	Clave
7. Gato mec. Norte Implementos 4,000 lbs	G

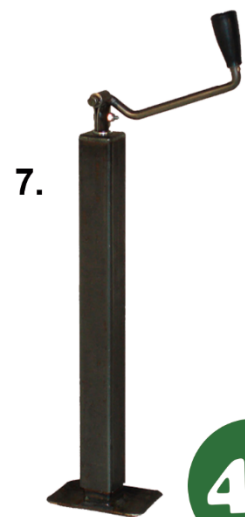

## Gatos mecánicos Ram

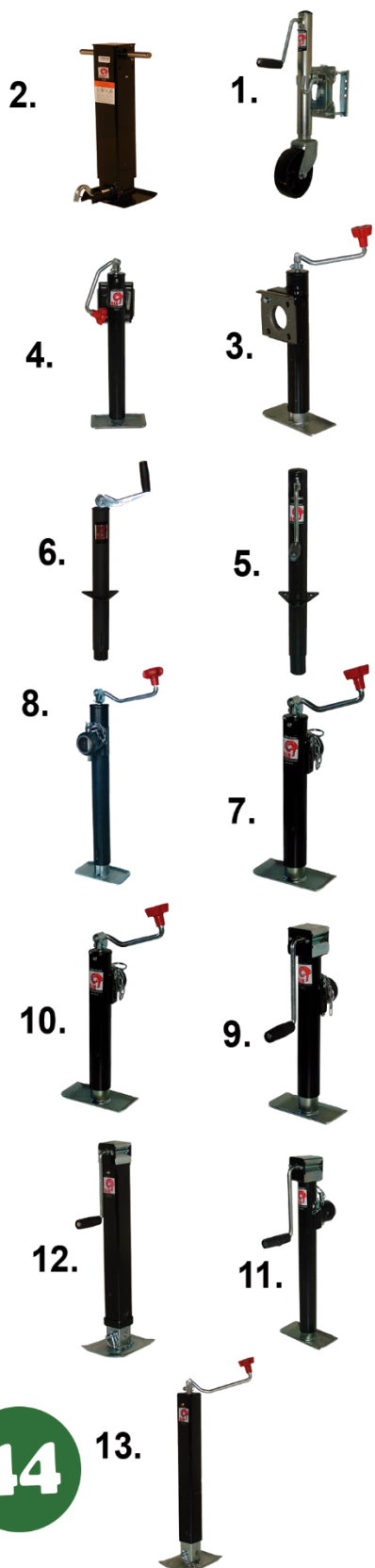

	<b>Descripción</b>	<b>Clave</b>
1.	Gato mec. Ram 1,000 lbs c/rueda	MJ1001B
2.	Gato mec. Ram 10,000 lbs	G10KJWH
3.	Gato mec. Ram 2,000 lbs corto abatible c/base	G2AB
4.	Gato mec. Ram 2,000 lbs largo abatible c/base	TJB-2002-B
5.	Gato mec. Ram 2,000 lbs palanca al lado	TJA-2000S
6.	Gato mec. Ram 2,000 lbs palanca arriba	427002
7.	Gato mec. Ram 2,000 lbs corto c/tubo	TJP-2001-B
8.	Gato mec. Ram 2,000 lbs largo c/tubo palanca arriba	TJP-2002-B
9.	Gato mec. Ram 3,000 lbs corto c/tubo palanca al lado	JISPMSW5
10.	Gato mec. Ram 3,000 lbs corto c/tubo palanca arriba	JISPMTW5
11.	Gato mec. Ram 3,000 lbs largo c/tubo palanca al lado	TJP-502S-B
12.	Gato mec. Ram 7,000 lbs palanca al lado	7950182
13.	Gato mec. Ram 7,000 lbs palanca arriba	TJD-7000
14.	Gato mec. Ram 3,000 lbs palanca arriba	TJA-5000-B

## Engranajes

### Descripción

### Clave

- |    |  |        |
|----|--|--------|
| 1. | Engrane p/gato con rosca p/lado 2,000 lbs    | EGR    |
| 2. | Engrane p/gato Ram 7,000 lbs palanca al lado | EG7000 |



## Gato Eléctrico

### Descripción

### Clave

- |    |                              |        |
|----|------------------------------|--------|
| 3. | Gato eléctrico de 12,000 lbs | 185400 |
|----|------------------------------|--------|

## Gato Estabilizador

### Descripción

### Clave

- |    |                    |    |
|----|--------------------|----|
| 4. | Gato estabilizador | GE |
|----|--------------------|----|

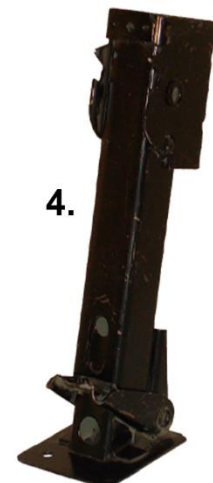

## Manivelas



### Descripción

### Clave

- |    |  |         |
|----|--|---------|
| 1. | Manivela p/gato 10,000 lbs                   | 015181  |
| 2. | Manivela p/gato de palanca arriba botón rojo | 7950099 |

## Palancas

### Descripción

### Clave

- |    |                                 |        |
|----|---------------------------------|--------|
| 3. | Palanca a lado p/gato 7,000 lbs | PL7000 |
|----|---------------------------------|--------|

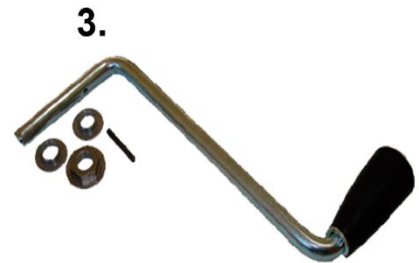

## Patas p/gato

### Descripción

### Clave

- |    |   |            |
|----|---|------------|
| 4. | Pata p/gato Ram 7,000 lbs               | 7950075    |
| 5. | Pata p/gato 2,000 lbs larga sin engrane | PATAGATOSE |
| 6. | Pata p/gato Ram 2,000 lbs corta         | 7950105    |
| 7. | Pata p/gato Towking 2,000 lbs corta     | 701073     |

## Ruedas

Descripción	Clave
1. Rueda p/gato mec. 2,000 lbs sin engrane	RGR
2. Rueda p/gato mec. Ram 2,000 lbs	500245



## Tubos

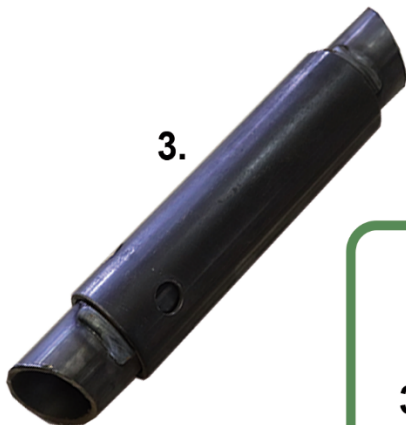

Descripción	Clave
3. Tubo giratorio p/gato	TUBOGATO



# Jalones y Bolas



[www.trailer.com.mx](http://www.trailer.com.mx)

# Jalones y Bolas



## Jalones Tipo A 2"

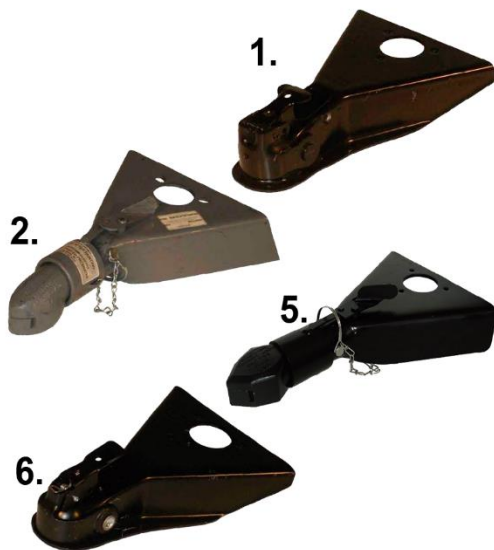

### Descripción

### Clave

1. Jalón p/bola 2" 5,000 lbs Atwood	80072*
2. Jalón p/bola 2" 5,000 lbs Bulldog	28287
3. Jalón p/bola 2" 7,000 lbs Bulldog	A2-JB7N
4. Jalón p/bola 2" 7,000 lbs NCM	JBD27KNCM
5. Jalón p/bola 2" 7,000 lbs Ram	CIB27AF
6. Jalón p/bola 2" 8,000 lbs A-FRAME	6750512-TT
7. Jalón p/bola 2" 8,000 lbs Ram	CIA28AF

## Jalones para Lanza Recta

### Descripción

### Clave

8. Jalón p/bola 2" x 2" 3500 lbs	22200
9. Jalón p/bola 2" x 2-1/2" 3,500 lbs	22250
10. Jalón p/bola 2" x 3" 3,500 lbs	22300
11. Jalón p/bola 2" y canal de 3" 3,500 lbs Atwood	6750020
12. Jalón p/bola 2" y canal de 3" 5,000 lbs Bulldog	6750022
13. Jalón p/bola 2" y canal de 3" 7,000 lbs Bulldog	6750063
14. Jalón p/bola 2-5/16" 12,500 lbs Bulldog	4B8L
15. Jalón p/bola 2-5/16" 12,500 lbs Ram	CA-5290-B
16. Jalón p/bola 2-5/16" 15,000 lbs Bulldog	B2-JF2-516
17. Jalón p/bola 2-5/16" p/freno hidráulico 12,500 lbs Bulldog	16039
18. Jalón p/bola 2-5/16" y canal de 3" 12,500 lbs Bulldog	6750029



## Jalones Actuador hidráulico

### Descripción

### Clave

1. Jalón Actuador ADJ. W/OC  
20,000 lbs

J-DA20AF

1.

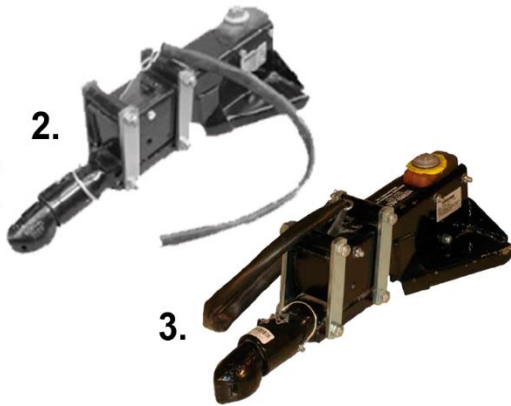
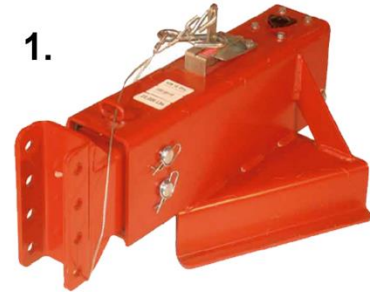

2.

3.

## Jalones Tipo A hidráulico

### Descripción

### Clave

2. Jalón p/bola de 2" p/freno  
hidráulico 6,000 lbs Atwood
3. Jalón p/bola de 2" p/freno  
hidráulico 7,000 lbs Bulldog

9050009

16006

## Jalones ajustables Bola de 2" y 2-5/16"

### Descripción

### Clave

4. Jalón ajustable Towking de 2"  
7,000 lbs
5. Jalón ajustable de 2" 7,000 lbs  
Bulldog
6. Jalón ajustable de 2" 7,000 lbs  
Ram
7. Jalón ajustable de 2-5/16" 12,500  
lbs Bulldog
8. Jalón ajustable de 2-5/16" 12,500  
lbs Ram
9. Jalón ajustable de 2-5/16" 14,000  
lbs Bulldog

703035

CB72A

CTA-190

028630

CTA-290

CA14

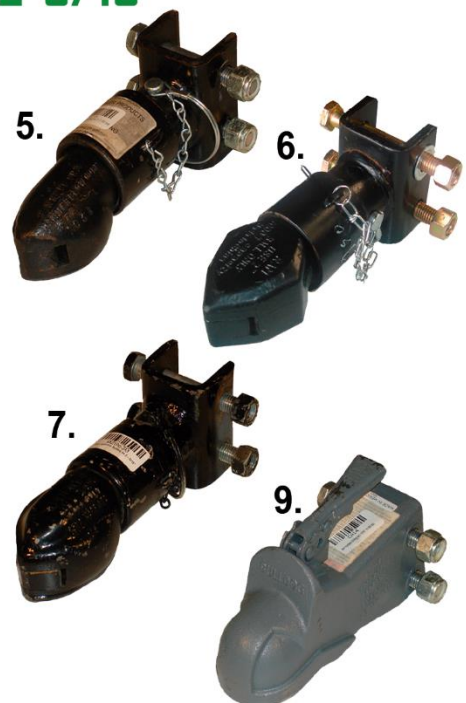

5.

6.

7.

9.



# Jalones y Bolas



## Jalones Mini Quinta Rueda

Descripción	Clave
1. Jalón quinta rueda	BFW0001



## Jalones ajustables Cuello de ganso



Descripción	Clave
2. Jalón ajustable p/cuello de ganso de 2-5/16" 20,000 lbs Bulldog	028852
3. Jalón ajustable p/cuello de ganso de 2-5/16" 20,000 lbs Ram	GC-20000
4. Jalón ajustable p/cuello de ganso de 2-5/16" 24,000 lbs Bulldog	6750080
5. Jalón ajustable p/cuello de ganso de 2-5/16" 25,000 lbs	GN COUPLER
6. Jalón ajustable p/cuello de ganso con perno rey	7150033

## Jalones Tow Bar

Descripción	Clave
7. Jalón Tow Bar 3,500 lbs	74500
8. Jalón Tow Bar 5,000 lbs CURT	T-745
9. Jalón B&W	TS35100B



## Jalones De Argolla



	Descripción	Clave
1.	Jalón de argolla soldable 10,000 lbs	LW10
2.	Jalón de argolla ajustable 14,000 lbs	B16137
3.	Jalón de argolla ajustable 24,000 lbs	855001
4.	Jalón de argolla atornillable 35,000 lbs	DB1250-15

## Jalones de gancho

	Descripción	Clave
5.	Jalón de gancho con bola de 2" y bara 10,000 lbs CURT	48007
6.	Jalón de gancho con bola de 2-5/16" y bara 12,000 lbs	RM62516
7.	Jalón de gancho con bola 16,000 lbs	69972
8.	Jalón de gancho 30,000 lbs	PH-15

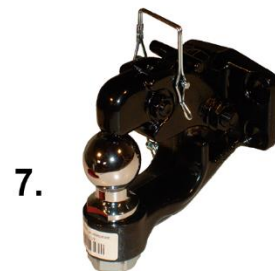

# Jalones y Bolas



## Jalones para Chasis

### Descripción

### Clave

- |     |  |       |
|-----|--|-------|
| 1.  | Chevy Silverado, Sierra 1500 07-18 CURT                  | 13301 |
| 2.  | Chevy Silverado, Sierra,Z71 1500,2500LD 99-13 CURT       | 13322 |
| 3.  | Ford F150, 250LD 97-03 CURT                              | 13038 |
| 4.  | Ford Escape / Mazda Tribute / Mercury Mariner 05-11 CURT | 13650 |
| 5.  | Jeep Cherokee 14-17 CURT                                 | 13172 |
| 6.  | Jepp Wrangler 07-15 CURT                                 | 13432 |
| 7.  | Jeep Wrangler 97-06 CURT                                 | 13408 |
| 8.  | Mazda Pickups 94-09 / Ford Ranger 83-11 CURT             | 13138 |
| 9.  | Multiusos Full Size Pickups 60-95                        | 81090 |
| 10. | Multiusos Full Size Pickups 72-07                        | 82270 |
| 11. | Nissan Frontier 2DR 00-04                                | 13831 |
| 12. | Nissan Frontier 4DR 00-04                                | 13841 |
| 13. | Semi Custom 58710  | 58710 |
| 14. | Semi Custom 58700  | 58700 |



## Jalones para Chasis

### Descripción

### Clave

Descripción	Clave
1. Toyota Fj Crusier 07-09 CURT	13367
2. Toyota Highlander 14-16 CURT	13200
3. Toyota Tundra except TRD Sport 07-18 CURT	13198
4. Acura MDX SUV 14 CURT	13146
5. Chevrolet Colorado 15-18	RENYCOL1518
6. Chevrolet Colorado/Canyon 04-12 CURT	13252
7. Chevrolet S-10 12-17	RENYS1017
8. Chevrolet Tornado 11-18	RENYTOR11
9. Dodge 67-02 CURT	13310
10. Dodge Pickup 02 CURT	13326
11. Dodge Pickup 03-13 CURT	13333
12. Dodge Ram 03-13	RENYDODGE0313
13. Durango/Grans Cherokee 11-15 CURT	13182
14. Ford Ranger 12-17	RENYRANGER16
15. Grand Cheroкке EXCEPT SRT8 05-10 CURT	13251
16. Mitsubishi L200 15-17	RENY20016
17. Mitsubishi L200 15-17 Diesel	RENYL20017D
18. Nissan Estaquitas NP300 15-18	RENYESTAQUITAS17
19. Nissan Frontier 05-16 CURT	13241
20. Nissan Frontier NP300 16-19	RENYNP30016
21. Nissan NP300 00-15	RENYNP3002000

6.



9.

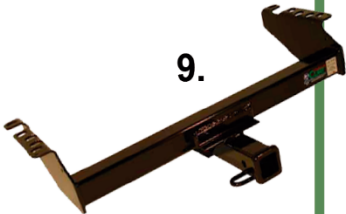

10.



17.

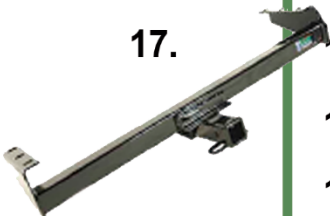

# Jalones y Bolas



## Jalones para Chasis

### Descripción

### Clave

- |  |                    |
|--|--------------------|
| 1. Nissan NP300 Cabina Sencilla Caja Larga 15-17 | RENYNP300CSCL1517  |
| 2. Nissan Pathfinder 13-17                       | RENYPATHFINDER1317 |
| 3. Toyota 84-94 CURT                             | 13086              |
| 4. Toyota Highlander 08-13 CURT                  | 13534              |
| 5. Toyota Hilux 16-19                            | RENYHILUX16        |
| 6. Toyota Tacoma 16-18 CURT                      | 13264              |
| 7. Toyota Tacoma 16-18                           | RENYTACOMA16       |
| 8. Toyota Tacoma 15-15 CURT                      | 13323              |
| 9. Volkswagen Amarok 10-17                       | RENYAMAROK17       |

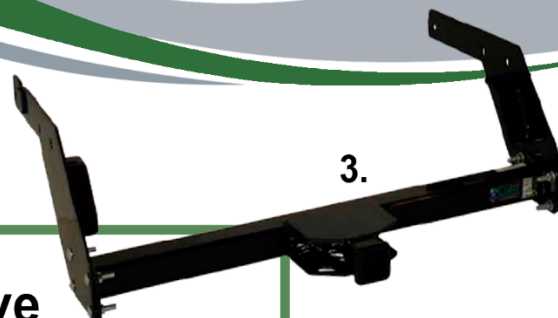

## Jalón Canasta

### Descripción

### Clave

- |  |       |
|--|-------|
| 10. Con canasta de carga y mango doblable CURT | 18131 |
|--|-------|



## Jalones Perno Rey

1.



### Descripción

### Clave

1. Jalón Perno Rey

JPR

### Descripción

### Clave

2. Base para jalón ajustable (corta)

6750131

3. Base para jalón ajustable (larga)

6750032

4. Base para jalón ajustable Towking (corta)

703018

5. Base para jalón ajustable Towking (larga)

703019

## Bases para jalón

2.



3.



## Kit de reparación



### Descripción

### Clave

6. Kit de reparación para jalón recto 3,500 lbs.

6750111

7. Kit de de reparación para perico 880

880RK

## Bolas p/jalón

Descripción	Clave
1. Bola de 3" de repuesto p/jalón B&W	2025BW
2. Bola de repuesto p/jalón CURT	60603
3. Bola de repuesto p/jalón B&W	2000
4. Bola p/jalón de 2" x 3/4" x 2-1/8" 3,500 lbs CURT	A-18
5. Bola p/jalón de 1-7/8" x 1" x 2-1/8" 3,500 lbs	A-2
6. Bola p/jalón Towking de 2" x 1" x 2-1/4" 5,000 lbs	704005
7. Bola p/jalón de 2" x 1" x 2-1/8" 6,000 lbs CURT	A-4
8. Bola p/jalón de 2" x 1" x 2-1/8" 7,500 lbs CURT	A-37
9. Bola p/jalón de 2" x 1" x 3" 6,000 lbs CURT	A-20
10. Bola p/jalón Towking de 2-5/16" x 1-1/4" x 2-5/8" 10,000 lbs	704010
11. Bola p/jalón de 2" x 1-1/4" x 2-1/4" repuesto 10,000 lbs CURT	E119R
12. Bola p/jalón de 2" x 1-1/4" x 2-5/8" 10,000 lbs CURT	A-90
13. Bola p/jalón de 2" x 1" x 2-1/4" 12,000 lbs CURT	A-38
14. Bola p/jalón de 2-5/16" x 1-1/4" x 3-1/4" 30,000 lbs negra	B25630K

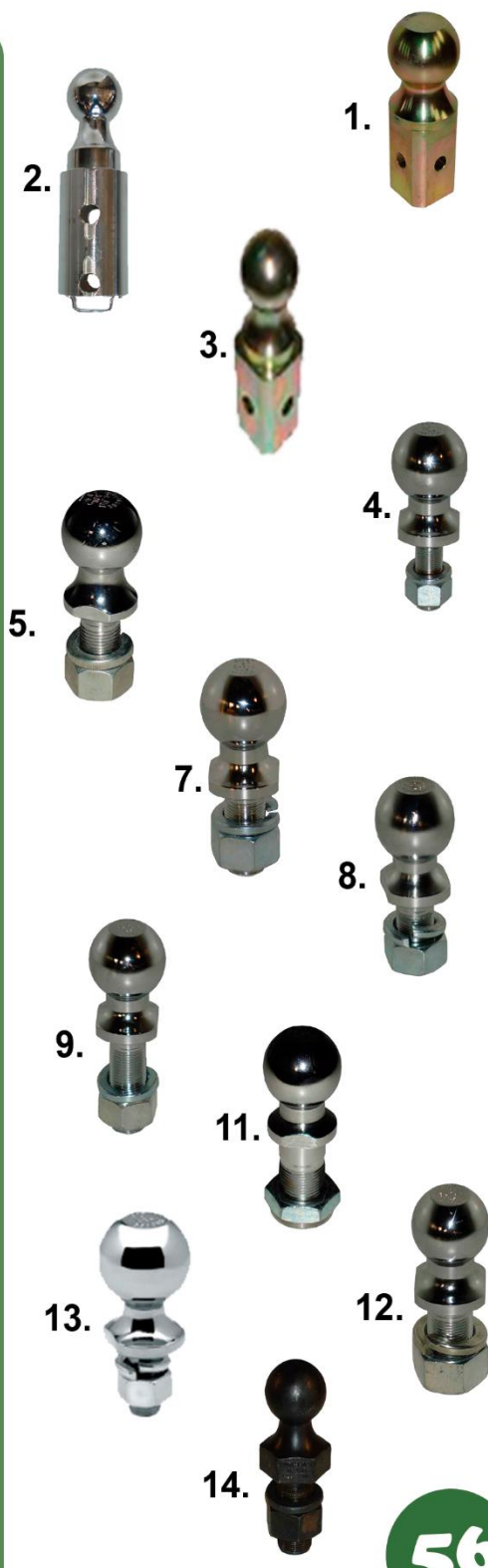

## Bolas p/jalón

### Descripción

### Clave

- |    |   |         |
|----|---|---------|
| 1. | Bola p/jalón de 2-5/16" x 1" x 3"<br>6,000 lbs CURT                 | A-21    |
| 2. | Bola p/jalón de 2-5/16" x 1" x 2-1/8"<br>7,500 lbs CURT             | A-5     |
| 3. | Bola p/jalón de 2-5/16" x 1-1/4" x<br>2-5/8" 10,000 lbs CURT        | A-35    |
| 4. | Bola p/jalón de 2-5/16" x 1" x 2-1/4"<br>12,000 lbs CURT            | A-39    |
| 5. | Bola p/jalón de 2-5/16" x 1-1/4" x<br>2-5/8" 25,000 lbs CURT        | A-43    |
| 6. | Bola p/jalón de 2-5/16" x 2-3/16"<br>x 4" 30,000 lbs Tex Trail      | 6300063 |
| 7. | Bola p/jalón de 2-5/16" perno 2" x 4"<br>alto de bola (30,000 Lbs.) | 6300060 |







# Llantas y Rines



[www.trailer.com.mx](http://www.trailer.com.mx)

## Kit de llanta y rin

	<b>Descripción</b>	<b>Clave</b>
1.	Kit de rin 12" y llanta (4.80-12) 6pr 5 birlos	9400541
2.	Kit de rin 13" y llanta radial (ST175/80R13)	417841
3.	Kit de rin 15" y llanta convencional (7.00-15)	430651
4.	Kit de rin 15" y llanta radial (ST205/75R15)	434701
5.	Kit de rin 15" y llanta radial (ST25/75R15) 8PR	K225
6.	Kit de rin 15" y llanta radial (ST225/75R15) aro cromado	16235
7.	Kit de rin 16" dualle y llanta ST235/80R16	435031
8.	Kit de rin 16" y llanta radial (ST235/80R16)	417921
9.	Kit de rin 16" y llanta radial 14 Lonas ST235/80R16	K2358016L
10.	Kit de rin 17-1/2" y llanta radial (ST235/75R17.5)	K17523575
11.	Kit de rin 17-1/5" y llanta radial (ST235/75R17.5) Dual	K17523575D
12.	Kit de rin 8" y llanta (5.70-8) 8pr 5 birlos	K5.78
13.	Kit de rin 8" y llanta radial (4.80-8)	429811



# Llantas y Rines



## Llantas

Descripción	Clave
1. Llanta convencional rin 15" (7.00-15)	CONV
2. Llanta convencional rin 16" (7.50-16)	CONV16
3. Llanta radial rin 13" P175/70R13	LL-13
4. Llanta radial rin 16" (235/80R16)	WR089-2358016E



## Rines

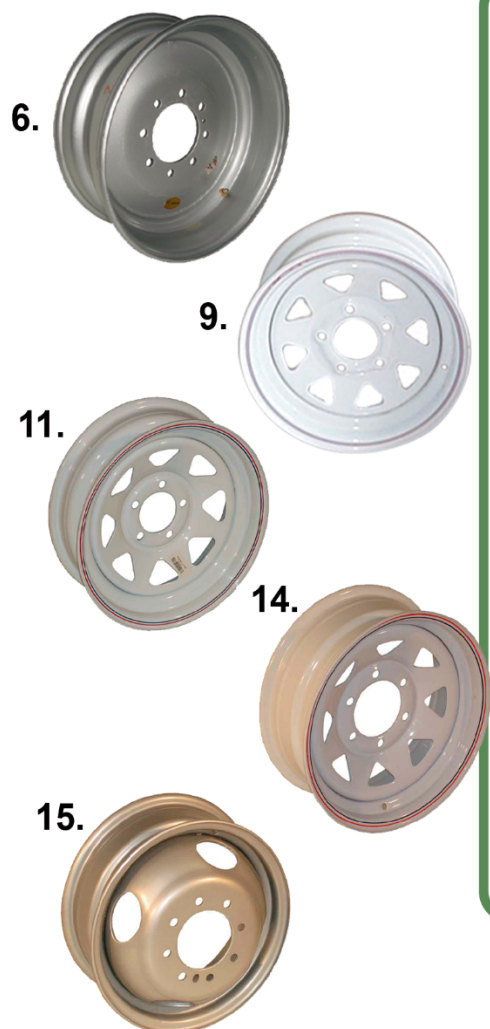

Descripción	Clave
5. Rin 17.5 p/rueda sencilla	R-17.5
6. Rin 13" x 4.5" en 4 birlos (4/4)	R-134
7. Rin de 13" x 4.5" en 5 birlos (5/4.5) Dodge 12	R-13
8. Rin de 14" x 6" 5 birlos (5/4.5) Dodge	R-14
9. Rin de 15" x 5" 5 birlos (5/4.5) Dodge	R-145
10. Rin de 15" x 5" 5 birlos (5/5) Chevy	R155
11. Rin de 15" x 5" 5 birlos (5/5.5) Ford	R155.5
12. Rin de 15" x 6" 6 birlos (6/5.5)	R-156
13. Rin de 16" x 6" 6 birlos (6/5.5)	R-16-6
14. Rin de 16" x 6" 8 birlos (8/6.5)	R-16
15. Rin de 16" x 6" 8 birlos (8/6.5) Dual	R-16G



# Muelles



[www.trailer.com.mx](http://www.trailer.com.mx)

## Muelles Doble ojo

### Descripción

### Clave

- |    |   |         |
|----|---|---------|
| 3. | Muelle 3 hojas normal 750 lbs             | M3HNC   |
| 4. | Muelle 4 hojas normal 1,750 lbs           | SW4B    |
| 5. | Muelle 3 hojas normal 1,800 lbs           | G2-M32N |
| 6. | Muelle 4 hojas normal reforzado 2,400 lbs | M4HR    |
| 7. | Muelle 5 hojas normal 2,900 lbs           | 5WS     |
| 8. | Muelle 6 hojas normal 3,300 lbs           | G3-M66N |



## Muelles Deslizables

### Descripción

### Clave

- |     |   |           |
|-----|---|-----------|
| 9.  | Muelle 3 hojas I-slip 750 lbs                       | G4-M3.75S |
| 10. | Muelle 5 hojas I-slip 1,250 lbs 24" largo           | M5HS      |
| 11. | Muelle 5 hojas I-slip 2,900 lbs                     | G3-M54S   |
| 12. | Muelle 6 hojas I-slip 4,000 lbs                     | G2-M66S   |
| 13. | Muelle 5 hojas I-slip 5,000 lbs                     | 9150027   |
| 14. | Muelle 5 hojas I-slip de 2-1/2" x 32-1/2" 5,000 lbs | 9150029   |



## Maestra y Segunda Maestra

### Descripción

### Clave

- |    |                             |         |
|----|-----------------------------|---------|
| 1. | Maestra de muelles          | MAESTRA |
| 2. | Segunda maestra con ganchos | SW2RG   |



# Suspensión



# Suspensión



## Amortiguadores

### Descripción

### Clave

- |   |             |
|---|-------------|
| 1. Amortiguador S24579                  | S24579      |
| 2. Amortiguador 15" 65 PSI              | GSS 6347 UI |
| 3. Amortiguador 20" 34 PSI              | GSS 6395 UP |
| 4. Amortiguador 20" 65 PSI              | GSS 6397 UF |
| 5. Amortiguador de gas de 13.78" 30.91" | 1439EU      |
| 6. Bola p/amortiguador de gas           | GS-10MM-BS  |

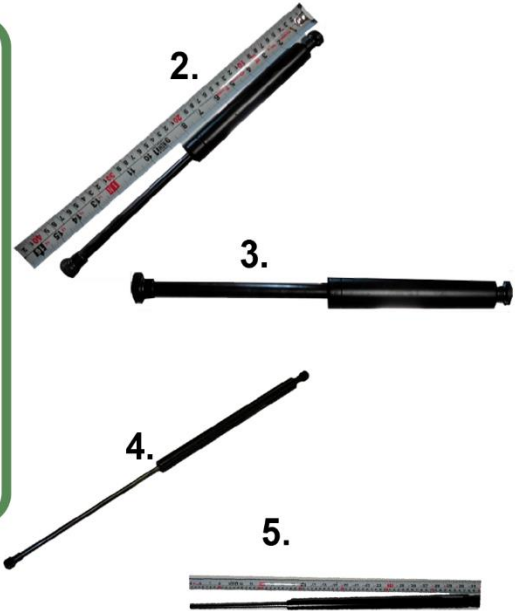

## Balancines

### Descripción

### Clave

- |  |          |
|--|----------|
| 7. Balancin de 3,500 lbs (equalizador) | 4101-1   |
| 8. Balancin de 6,000 lbs (equalizador) | BAL 6000 |

## Bujes

### Descripción

### Clave

- |  |          |
|--|----------|
| 9. Buje de 1" x 2-3/4" p/balancines            | BUJE6    |
| 10. Buje de 9/16" x 1-3/4" p/muelle y balancin | 4370     |
| 11. Buje de plástico 3/4" x 1-3/4" x 2-3/4"    | 90000047 |

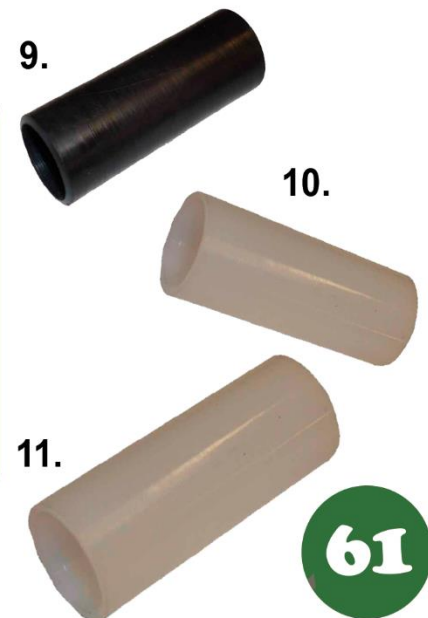

## Colgantes

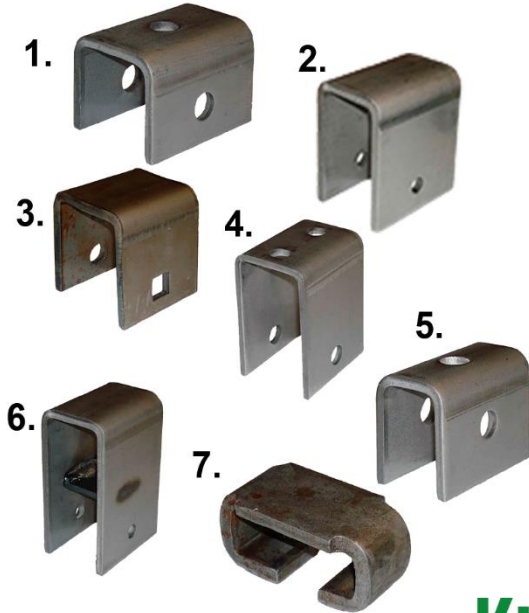

Descripción	Clave
1. Colgante delantero 2,000-3,500 lbs x eje C D	
2. Colgante delantero 6,000 lbs x eje	15843
3. Colgante mediano 6,000 lbs x eje	15863
4. Colgante normal 3,500 lbs x eje	C 35
5. Colgante trasero 2,000-3,500 lbs x eje	C T
6. Colgante trasero 6,000 lbs x eje	15853
7. Colgante trasero c-clip 2,000 lbs x eje	CCC

## Kit de suspensión

Descripción	Clave
8. Kit de suspensión 2,000 lbs 1 eje c/clip	4104
9. Kit de suspensión 2,000-3,500 lbs 1 eje completo	4103
10. Kit de suspensión tandem 7,000 lbs 2 ejes completo	4105
14. Kit de suspensión 10,000 lbs x eje balancin de 42-1/2"	HAP-257-02
12. Kit de suspensión 10,000 lbs x eje hanger	HAP 158 00
13. Kit de suspensión 14,000 lbs 2 ejes c/tornillos y tuercas	288
14. Kit de suspensión 14,000 lbs 2 ejes	4114H

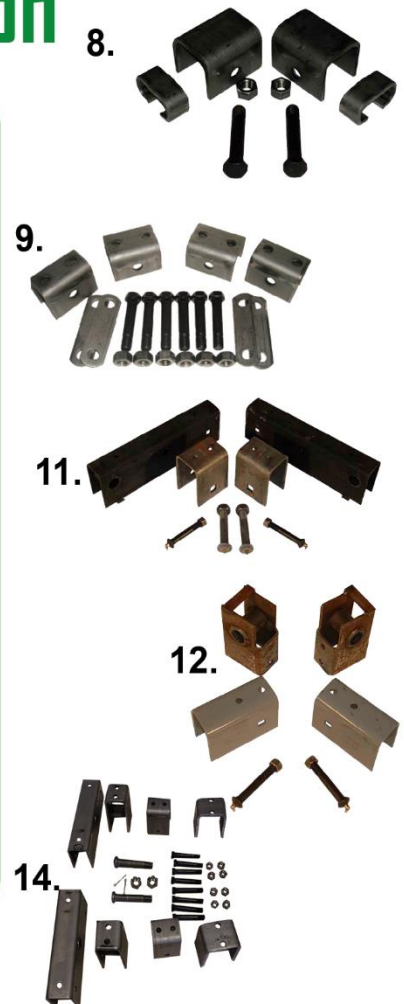



# Suspensión



## Solerita

1.



### Descripción

### Clave

1. Solerita p/suspensión de remolque  
2,000 - 3,500 lbs

SR

## Suspensión

### Descripción

### Clave

2. Suspensión Completa HJ-Rockwell  
QuickAlign 30k 15R
3. Suspensión de aire de 15" HT-300  
Hendrickson
4. Suspensión TA-300T de 15" con eje  
soldado de 77-1/2"
5. Suspensión TA-300T de 15" con eje  
soldado de 77-1/2" freno de disco
6. Suspensión ampro de 15"

HJ.300TB.15.RO.HN

HT300TB-15-001

TA300T

TA300T20A.170

AMPROMK15

4.

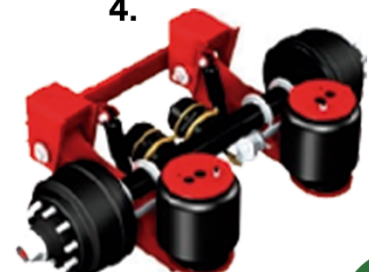

# Luces



## Kit de Luces

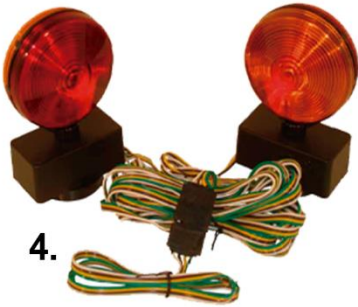

4.



5.

### Descripción

### Clave

- |    |                                 |         |
|----|---------------------------------|---------|
| 1. | LED Towing para remolcar c/imán | 751003S |
| 2. | Towing                          | 751006  |
| 3. | Towing para remolcar c/imán     | 751003  |
| 4. | Para remolcar con imán          | 31800K  |
| 5. | Para remolque completo          | M31101K |
| 6. | Sumergible LED Towing           | 751002  |
| 7. | Sumergible Towing               | 751001  |

## Lámparas

### Descripción

### Clave

- |     |   |          |
|-----|---|----------|
| 8.  | 2" Ambar c/Grommet 2" y conector p/lámpara 2" y 2-1/2"      | LGROTEA2 |
| 9.  | Bicolor p/fender derecho de led de 3/4                      | M277K    |
| 10. | Bicolor p/fender izquierdo de led de 3/4                    | M277KL   |
| 11. | 4 LED ovalada de 2.559" x 6.535 Ámbar c/aro cromado         | 8038CA   |
| 12. | 4 LED ovalada de 2.559" x 6.535 Ámbar c/aro cromado (Grote) | 45583    |
| 13. | 4 LED ovalada de 2.559" x 6.535 Roja c/aro cromado          | 8038CR   |
| 14. | Sellada LED Roja de 4" con arillo                           | 8002R    |
| 15. | Sellada de 3/4" de 1 LED Ámbar                              | 8063A    |



## Luces LED con Hule y Enchufe



Descripción	Clave
1. LED roja redonda 2"	8016R
2. LED roja redonda 2-1/2"	8014R
3. LED roja redonda 4-5/16"	8014R
4. LED ámbar redonda de 2"	8016A
5. LED ámbar redonda 2-1/2"	8014A
6. LED roja ovalada 6-1/2" x 2-1/4"	32600RK
7. LED roja ovalada 6-1/2" x 2-1/4" opaca	32607RK
8. LED ámbar ovalada 6-1/2" x 2-1/4"	32607AK
9. LED transparente ovalada 6-1/2" x 2-1/4"	32605CK
10. LED transparente ovalada 6-1/2" x 2-1/4" opaca	32607CK
11. LED clara redonda de 4-5/16"	32403CK
12. LED roja redonda de 4-5/16"	32401RK

## Luces con base metálica

Descripción	Clave
13. Luz ámbar de 4-1/2" x 2-3/16" (lateral)	119A
14. Luz roja de 4-1/2" x 2-3/16" (lateral)	119R

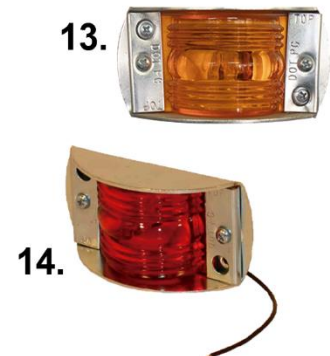

## LUCES con Hule y Enchufe

### Descripción

1. Ámbar ovalada lateral
2. Ámbar ovalada 6-1/2" x 2-1/4"
3. Ámbar rectangular 2-1/2" x 1-1/4"
4. Ámbar redonda 2"
5. Ámbar redonda 2-1/2"
6. Ámbar redonda 4"
7. Roja ovalada 6-1/2" x 2-1/4"
8. Roja rectangular 2-1/2" x 1-1/4"
9. Roja redonda 2"
10. Roja redonda 2-1/2"
11. Roja redonda 4"
12. Transparente redonda 4"
13. Transparente ovalada 6-1/2" x 2-1/4"

### Clave

- 2250-5A
- 2250 2A
- 2359A7
- 2241-1A
- 2240A
- 2250-1A
- 2250-2R
- 2359R7
- 2241-1R
- 2240R
- 2250-1R
- 2250 1C
- 2250-2C

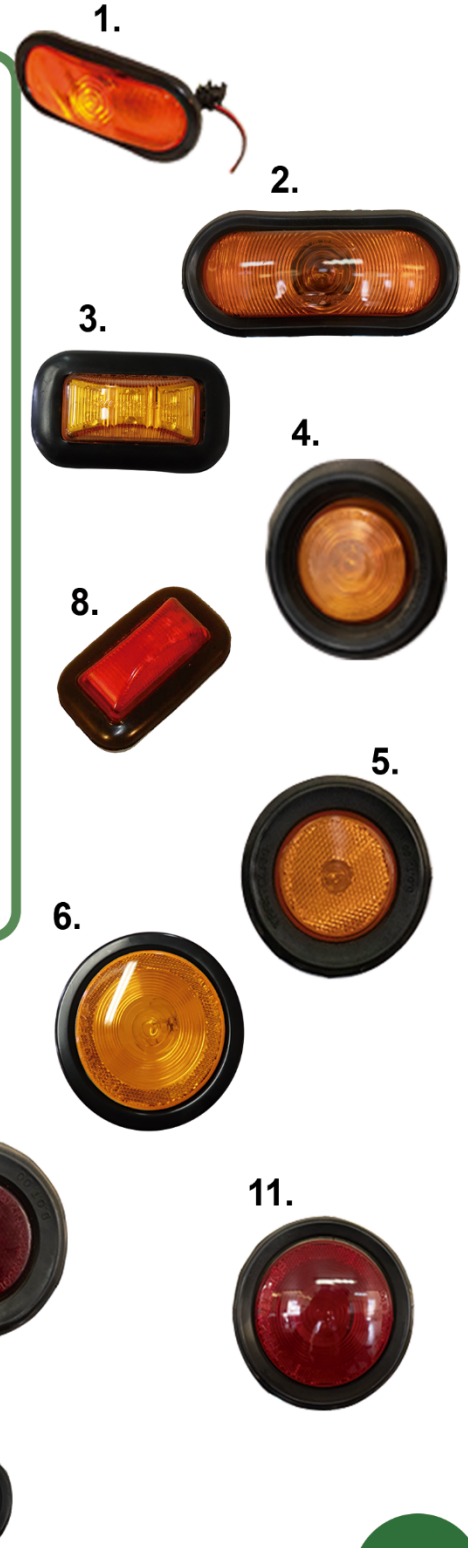

## Luces para Domo

### Descripción

1. Luz blanca redonda de 5" (interior)
2. Luz transparente rectangular de 6" x 3-1/2" (interior)
3. Luz transparente redonda de 7-1/8" x 3-1/8" (interior)

### Clave

- LIDRED  
31427  
LIDREC

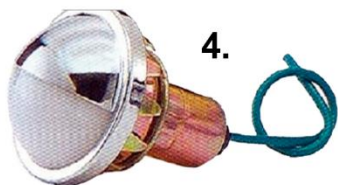

## Luces para Placa

### Descripción

4. Universal redonda (defensas)
5. Universal redondas (defensas) Towking
6. Transparente mini util
7. Transparente mini util Towking

### Clave

- 7788  
751064  
24434  
751066



## Luces c/base gris

### Descripción

8. Ámbar LED rectangular 2-1/2" x 1-1/4"
9. Roja LED rectangular 2-1/2" x 1-1/4"
10. Ámbar rectangular 2-1/2" x 1-1/4"
11. Roja rectangular 2-1/2" x 1-1/4"

### Clave

- 8354A  
8354R  
2354A  
2354R

## Reflectores

Descripción	Clave
1. Reflector ámbar B484A	B484A
2. Reflector Rojo B484R	B484R

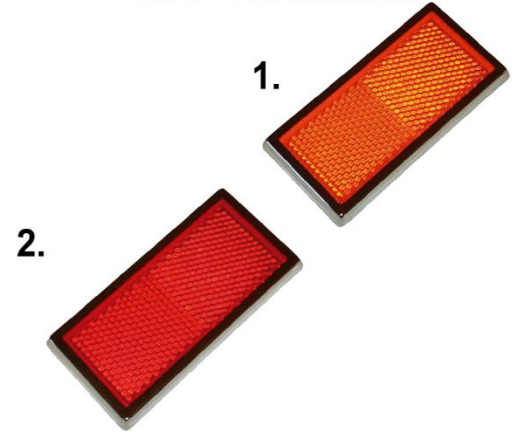

## Switch



Descripción	Clave
3. Switch de 12v cola de rata T60-0G00-1	7000151

## Accesorios p/ luces

Descripción	Clave
4. Grommet de hule ovalado 6"	T60-0G00-1
5. Grommet de hule redondo 2"	S30-0G00-1
6. Grommet p/luz 2-1/2" plano redondo	GROMMET



## Luces TecNic

**Producto  
Nuevo**

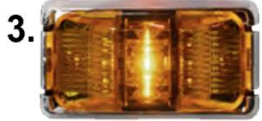

### Descripción

### Clave

- |   |            |
|---|------------|
| 1. Crome Bezel  | T10-0C00-1 |
| 2. Black Bezel  | T10-0B00-1 |
| 3. Model S150 Amber PC Sidemark<br>Amber Lens                         | S15-AA00-1 |
| 4. Model S150 Red PC Sidemark<br>Red Lens                             | S15-RR00-1 |
| 5. Model S150 Base Chrome   | S15-0S00-1 |
| 6. Model S150 Base Black  | S15-0B00-1 |
| 7. Model S150 Grommet   | S15-0G00-1 |
| 8. S17 Amber PCP2 Marker Light<br>Lens Pigtail                        | S17-AA0P-1 |
| 9. S17 Red PCP2 Marker Light<br>Red Lens Pigtail                      | S17-RR00-1 |
| 10. S17 Large Gasket with Chrome<br>Back Kit                          | S17-0GC0-1 |
| 11. Model S17 Black Base & Gasket<br>Large                            | S17-0GB0-1 |
| 12. 3.5" x .75" Surface mount P2/PC<br>rated Amber sidemark Hardwired | S18-AA01-1 |
| 13. 3.5" x .75" Surface Mount P2/PC<br>rated Red sidemark Hardwired   | S18-RR01-1 |
| 14. Base  | S18-0G00-1 |
| 15. 1" x 4" Red PC sidemark Red Lens                                  | S19-RR00-1 |
| 16. Chrome 1" x 4" Self Grounding Base                                | S19-0C00-1 |
| 17. 2" Oval Red Sidemark Red Lens<br>Pigtail Connection               | S21-RR00-1 |
| 18. 2" Oval Amber Sidemark Amber<br>Lens Pigtail Connection           | S21-AA0-1  |



## Luces TecNic

Descripción	Clave
1. 2" Round Amber Sidemarker Amber Lens	S30-AA00-1
2. 3/4" Mini P2 Amber Sidemarker Amber Lens, white ground wire	S33-AA09-1
3. 3/4" Mini P2 Red Sidemarker Red Lens withe ground wire	S33-RR09-1
4. Stainless steel trim ring for S33 and S34	S33-OS00-1
5. S33-0G00-1	S3-0G00-1
6. 4" Round STT Lamp Red Lens Grommet Mount 3 Pole	T40-RR0T-1
7. 4" Round Grommet	T40-0G00-1
8. 6" Oval Red STT Horiz. Grommet Mount Clear Lens 3 Pole	T60-RCHT-1
9. 6" Oval 6 LED STT Grommet Mount Red Lens 3 Pole	T66-RR0T-1
10. 6" Oval Stop Tail Turn Reverse Flange Red Lens Pigtail Connectors	T70-RWFP-1
11. 6" Oval Stop Tail Turn Reverse Grommet Red Lens Tri Pole Connectors	T70-RW0T-1

**Producto Nuevo**





# Defensas

**GMC**



**CHEVROLET**



**DODGE**

[www.trailer.com.mx](http://www.trailer.com.mx)

## Chevrolet Delantera frente con malla

Descripción	Clave
1. Diesel 15-19	FBMC 15-19
2. Diesel 11-14	FBMC 11-14
3. Diesel 7.5-10	FBMC 7.5-10
4. Diesel 03-07	FBMC 03-07
5. Diesel 99-02	FBMC 99-02



**CHEVROLET**



## Dodge Delantera frente con malla

Descripción	Clave
6. Diesel 19-20	FBMD 19-20
7. Diesel 10-18	FBMD 10-18
8. Diesel 06-09	FBMD 06-09
9. Diesel 03-05	FBMD 03-05
10. Diesel 95-02	FBMD 95-02

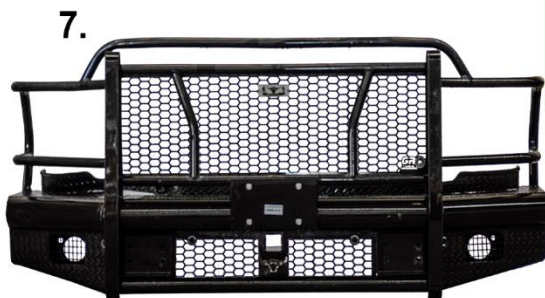

## Ford Delantera frente con malla



Descripción	Clave
1. Diesel 17-19	FBMF 17-19
2. Diesel 11-16	FBMF 11-16
3. Diesel 08-10	FMBF 08-10
4. Diesel 05-07	FBMF 05-07
5. Diesel 99-04	FBMF 99-04
6. Diesel 94-98	FBMF 94-98

- | Descripción     | Clave      |
|-----------------|------------|
| 1. Diesel 17-19 | FBMF 17-19 |
| 2. Diesel 11-16 | FBMF 11-16 |
| 3. Diesel 08-10 | FMBF 08-10 |
| 4. Diesel 05-07 | FBMF 05-07 |
| 5. Diesel 99-04 | FBMF 99-04 |
| 6. Diesel 94-98 | FBMF 94-98 |

1.



## GMC Delantera frente con malla



9.



Descripción	Clave
7. Diesel 20-21	FBMG 20-21
8. Diesel 15-18	FBMG 15-18
9. Diesel 11-14	FMBG 11-14
10. Diesel 7.5-10	FBMG 7.5-10
11. Diesel 03-07	FBMG 03-07
12. Diesel 99-02	FBMG 99-02

- | Descripción       | Clave       |
|-------------------|-------------|
| 7. Diesel 20-21   | FBMG 20-21  |
| 8. Diesel 15-18   | FBMG 15-18  |
| 9. Diesel 11-14   | FMBG 11-14  |
| 10. Diesel 7.5-10 | FBMG 7.5-10 |
| 11. Diesel 03-07  | FBMG 03-07  |
| 12. Diesel 99-02  | FBMG 99-02  |

## Chevrolet y GMC Trasera



Descripción	Clave
1. Diesel 11-18	RBCGD 11-18
2. Diesel 7.5-10	RBCGD 7.5-10
3. Diesel 03-07	RBCGD 03-07
4. Diesel 99-02	RBCGD 99-02

## Dodge Trasera

Descripción	Clave
5. Diesel 10-18	RBDD 10-18
6. Diesel 03-09	RBDD 03-05
7. Diesel 94-02	RBDD 94-02



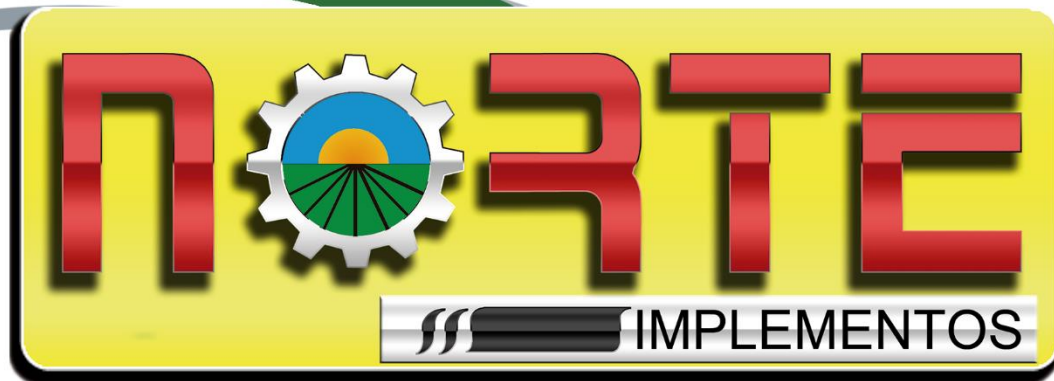

# Grupo Remolques del Norte, S.A. de C.V.

*Km. 7 Carr. Cuauhtémoc a Álvaro Obregón  
Cd. Cuauhtémoc, Chih.  
Tel. (625) 587 7200*

[www.trailer.com.mx](http://www.trailer.com.mx)